

## parallel connection kit - Mod. PS

Product code: PS-5E-65-0975

Datasheet creation date: 07/03/2025 15:41

Check the most updated document online [click here](#)



### TECHNICAL DATA

<b>Mod.</b>	PS-5E-65
<b>Size</b>	65

## parallel connection kit - Mod. PS

Product code: PS-5E-65-0975

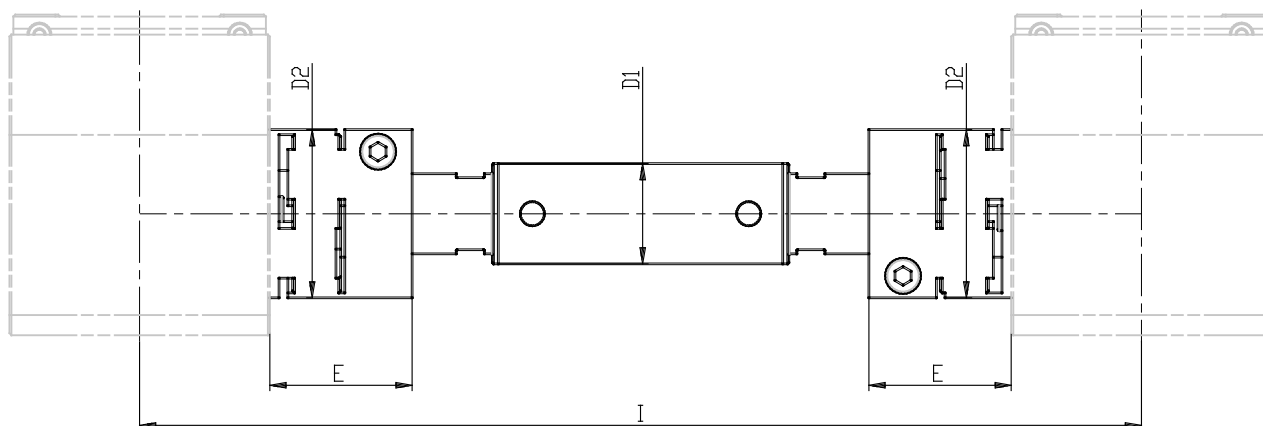

### **DIMENSIONS**

<b>I (mm)</b>	975
<b>D1 (mm)</b>	25
<b>D2 (mm)</b>	42
<b>E (mm)</b>	35.5