

parallel connection kit - Mod. PS

Product code: PS-5E-80-0500

Datasheet creation date: 07/03/2025 15:41

Check the most updated document online [click here](#)



TECHNICAL DATA

Mod.	PS-5E-80
Size	80

parallel connection kit - Mod. PS

Product code: PS-5E-80-0500

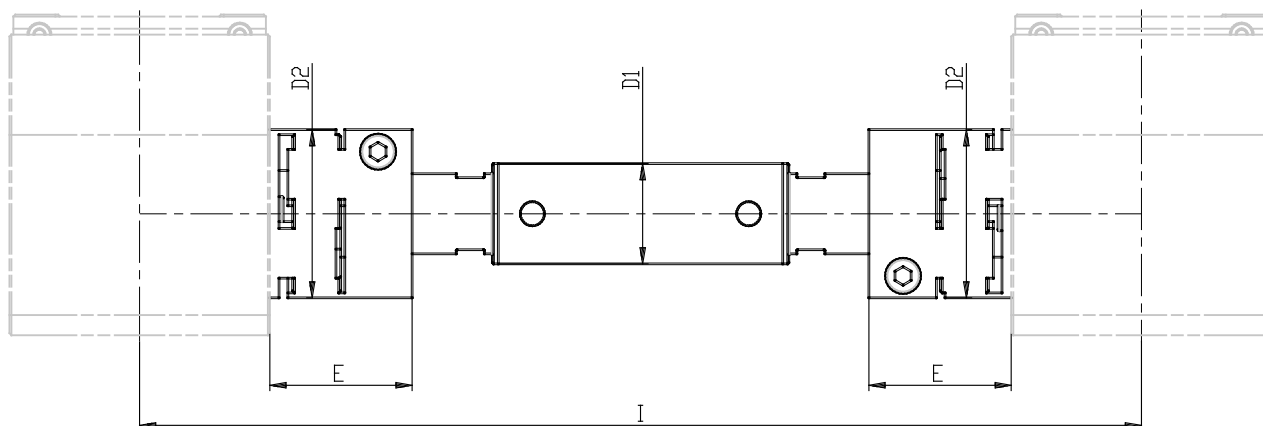

DIMENSIONS

I (mm)	500
D1 (mm)	32
D2 (mm)	56
E (mm)	40.0