

## parallel connection kit - Mod. PS

Product code: PS-5E-80-0600

Datasheet creation date: 07/03/2025 15:41

Check the most updated document online [click here](#)



### TECHNICAL DATA

<b>Mod.</b>	PS-5E-80
<b>Size</b>	80

## parallel connection kit - Mod. PS

Product code: PS-5E-80-0600

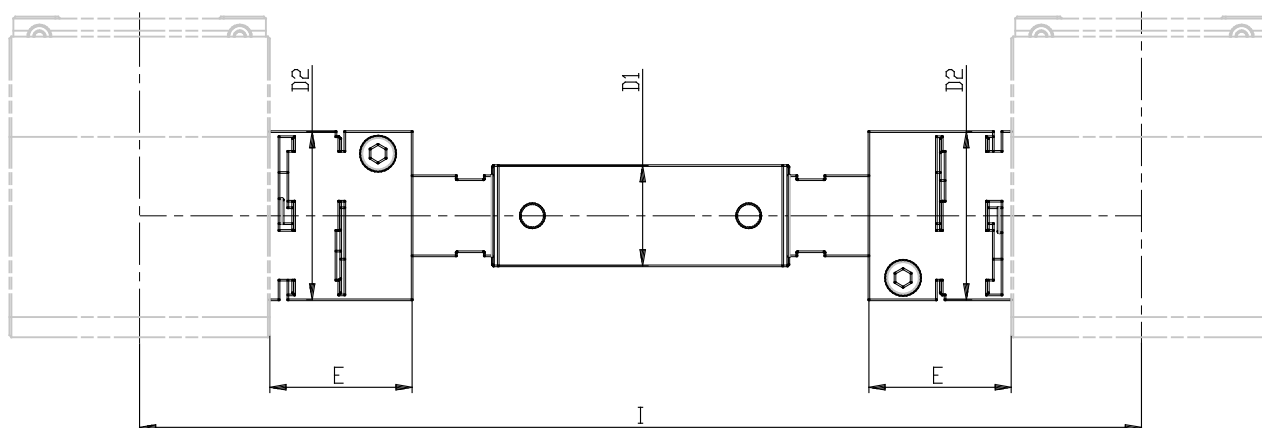

### **DIMENSIONS**

I (mm)	600
D1 (mm)	32
D2 (mm)	56
E (mm)	40.0