

Cylinders with integrated guide - Series QCT QCB

Product code: QCB2A032A030

Datasheet creation date: 09/03/2025 23:09

Check the most updated document online [click here](#)



TECHNICAL DATA

Series	QC
Version	B = linear ball bearings
Operation	2 = double acting
Materials	A = anodized aluminium body rolled stainless steel 303 piston rod hardened steel C50 columns for QCB
Diameter (mm)	32
Construction	A = standard
Stroke type	intermediate
Stroke (mm)	30

Cylinders with integrated guide - Series QCT QCB

Product code: QCB2A032A030

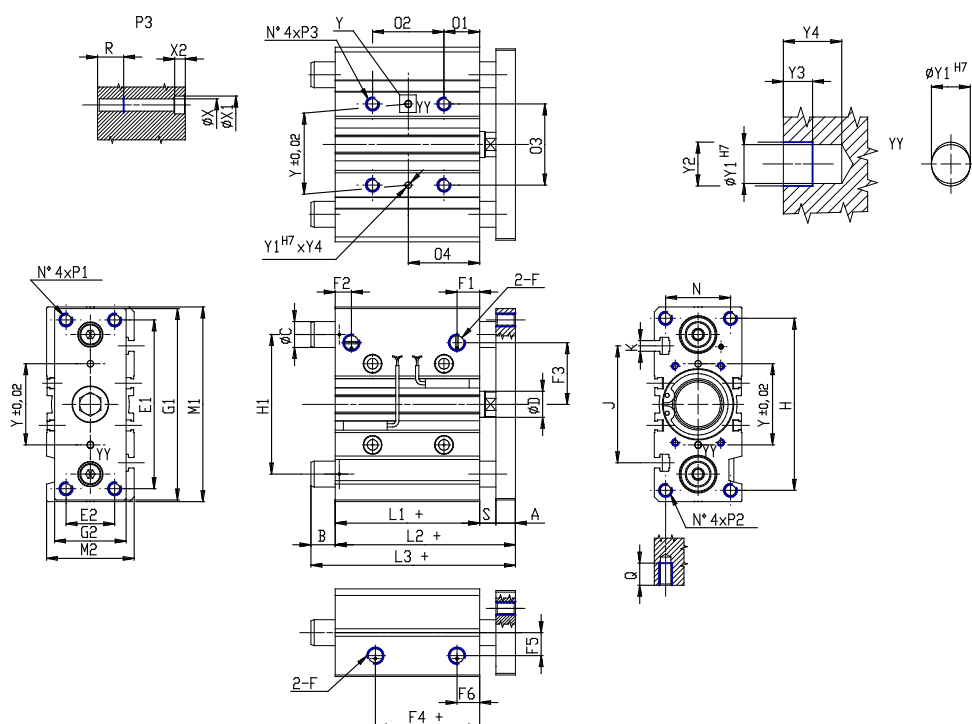

DIMENSIONS

L3 (mm)	86.0
C (mm)	16
B (mm)	26.5
O2 (mm)	24
O4 (mm)	33
A (mm)	12
D (mm)	16
E1 (mm)	96
E2 (mm)	30
F	G 1/8
F1 (mm)	12.5
F2 (mm)	9.5
F3 (mm)	34.0
F4 (mm)	7.0
F5 (mm)	15.0
F6 (mm)	12.5
G1 (mm)	110
G2 (mm)	45
H (mm)	98
H1 (mm)	78
L1 (mm)	37.5
L2 (mm)	59.5
M1 (mm)	112

M2 (mm)	48
N (mm)	34
O1 (mm)	21
O3 (mm)	42
P1	M8x1.25
P2	M8x1.25
P3	M8x1.25
Q (mm)	20
R (mm)	16
heavy (mm)	10
Y (mm)	42
Y1 (mm)	4
Y2 (mm)	4.5
Y3 (mm)	3
Y4 (mm)	6
X (mm)	6.5
X1 (mm)	11
X2 (mm)	6.5
J (mm)	63
K	M6