

## Cylinders with integrated guide - Series QCT QCB

Product code: QCT2A025A085

Datasheet creation date: 09/03/2025 22:59

Check the most updated document online [click here](#)



### TECHNICAL DATA

<b>Series</b>	QC
<b>Version</b>	T = sintered bronze bushes
<b>Operation</b>	2 = double acting
<b>Materials</b>	A = anodized aluminium body rolled stainless steel 303 piston rod rolled stainless steel 420B columns for QTC
<b>Diameter (mm)</b>	25
<b>Construction</b>	A = standard
<b>Stroke type</b>	intermediate
<b>Stroke (mm)</b>	85

## Cylinders with integrated guide - Series QCT QCB

Product code: QCT2A025A085

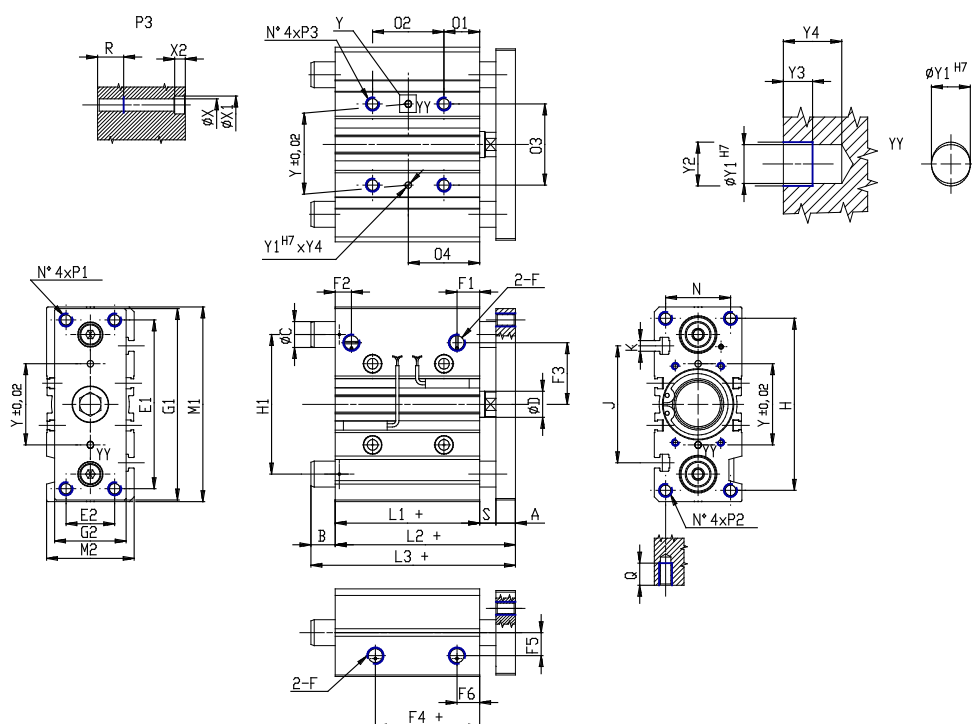

### DIMENSIONS

<b>L3 (mm)</b>	85.0
<b>C (mm)</b>	16
<b>B (mm)</b>	31.5
<b>O2 (mm)</b>	44
<b>O4 (mm)</b>	39
<b>A (mm)</b>	10
<b>D (mm)</b>	12
<b>E1 (mm)</b>	78
<b>E2 (mm)</b>	26
<b>F</b>	G 1/8
<b>F1 (mm)</b>	11.5
<b>F2 (mm)</b>	8.0
<b>F3 (mm)</b>	28.5
<b>F4 (mm)</b>	12.5
<b>F5 (mm)</b>	13.5
<b>F6 (mm)</b>	11.5
<b>G1 (mm)</b>	91
<b>G2 (mm)</b>	40
<b>H (mm)</b>	82
<b>H1 (mm)</b>	64
<b>L1 (mm)</b>	37.5
<b>L2 (mm)</b>	53.5
<b>M1 (mm)</b>	93

<b>M2 (mm)</b>	42
<b>N (mm)</b>	30
<b>O1 (mm)</b>	17
<b>O3 (mm)</b>	34
<b>P1</b>	M6x1
<b>P2</b>	M6x1
<b>P3</b>	M6x1
<b>Q (mm)</b>	15
<b>R (mm)</b>	12
<b>heavy (mm)</b>	6
<b>Y (mm)</b>	34
<b>Y1 (mm)</b>	4
<b>Y2 (mm)</b>	4.5
<b>Y3 (mm)</b>	3
<b>Y4 (mm)</b>	6
<b>X (mm)</b>	5.5
<b>X1 (mm)</b>	9
<b>X2 (mm)</b>	5.0
<b>J (mm)</b>	50
<b>K</b>	M5