

Cylinders with integrated guide - Series QCT QCB

Product code: QCT2A063A050

Datasheet creation date: 09/03/2025 23:03

Check the most updated document online [click here](#)



TECHNICAL DATA

Series	QC
Version	T = sintered bronze bushes
Operation	2 = double acting
Materials	A = anodized aluminium body rolled stainless steel 303 piston rod rolled stainless steel 420B columns for QTC
Diameter (mm)	63
Construction	A = standard
Stroke type	standard
Stroke (mm)	50

Cylinders with integrated guide - Series QCT QCB

Product code: QCT2A063A050

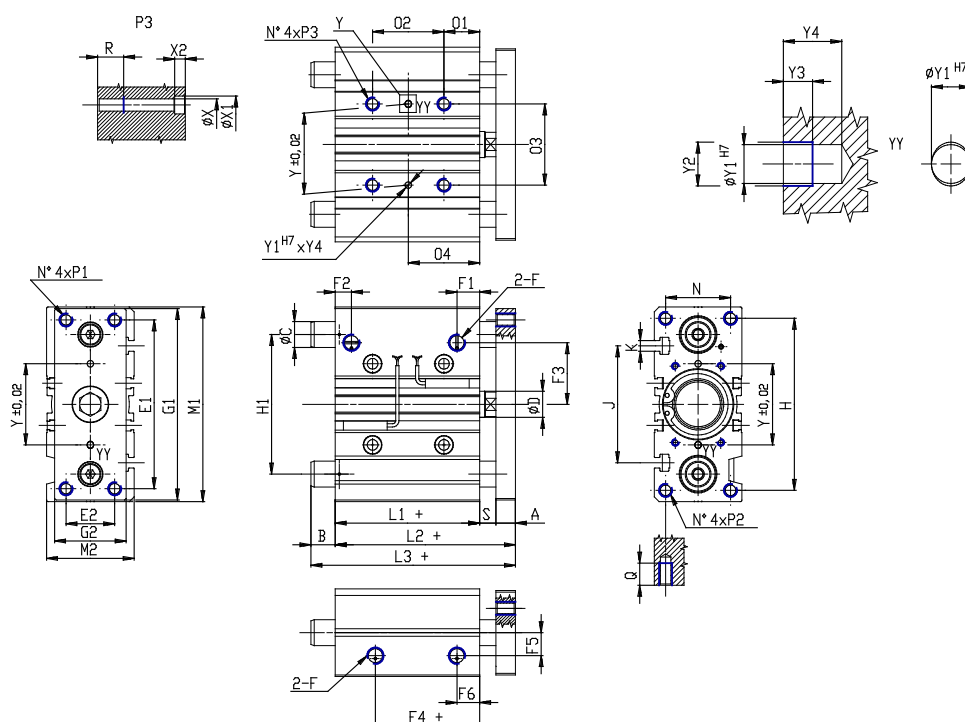

DIMENSIONS

L3 (mm)	98.5
C (mm)	25
B (mm)	21.5
O2 (mm)	52
O4 (mm)	50
A (mm)	15
D (mm)	20
E1 (mm)	130
E2 (mm)	50
F	G 1/4
F1 (mm)	14.5
F2 (mm)	11.4
F3 (mm)	55.0
F4 (mm)	12.0
F5 (mm)	28.0
F6 (mm)	14.5
G1 (mm)	158
G2 (mm)	70
H (mm)	142
H1 (mm)	124
L1 (mm)	49.0
L2 (mm)	77.0
M1 (mm)	162

M2 (mm)	78
N (mm)	58
O1 (mm)	58
O3 (mm)	80
P1	M10x1.5
P2	M10x1.5
P3	M10x1.5
Q (mm)	22
R (mm)	20
heavy (mm)	13
Y (mm)	80
Y1 (mm)	5
Y2 (mm)	6.0
Y3 (mm)	4
Y4 (mm)	8
X (mm)	8.5
X1 (mm)	14
X2 (mm)	8.5
J (mm)	110
K	M10