

Series QCTF-QCBF - Cylinders with integrated guide

Product code: QCTF2A020A025

Datasheet creation date: 09/03/2025 22:53

Check the most updated document online [click here](#)



TECHNICAL DATA

Series (mm)	QC
Diameter (mm)	20
Type of bearing	T = sintered bronze bushes
Version	F = body mounted with moving flanges
Operation	2 = double - acting
Materials	A = anodized aluminium body rolled stainless steel 303 piston rod rolled stainless steel 420B columns for QTC
Cushion	A = fixed mechanical cushion (standard)
Stroke type	intermediate
Stroke (mm)	25

Series QCTF-QCBF - Cylinders with integrated guide

Product code: QCTF2A020A025

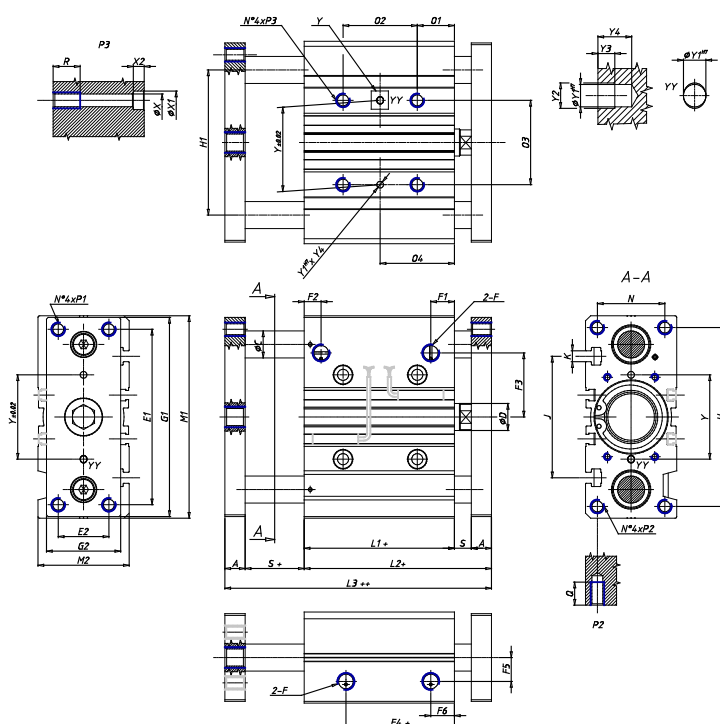

DIMENSIONS

C (mm)	10
O2 (mm)	24
O4 (mm)	29
A (mm)	10
D (mm)	10
E1 (mm)	70
E2 (mm)	18
F	G 1/8
F1 (mm)	10.5
F2 (mm)	10.5
F3 (mm)	25.0
F4 (mm)	12.5
F5 (mm)	11.5
F6 (mm)	10.5
G1 (mm)	81
G2 (mm)	30
G3 (mm)	-
H (mm)	72
H1 (mm)	54
L1 (mm)	37.0
L2 (mm)	53.0
L3 (mm)	69.0
M1 (mm)	83

M2 (mm)	36
N (mm)	24
O1 (mm)	17
O3 (mm)	28
P1	M5x0.8
P2	M5x0.8
P3	M6x1
Q (mm)	13
R (mm)	12
S (mm)	6
T (mm)	-
U (mm)	-
Y (mm)	28
Y1 (mm)	3
Y2 (mm)	3.5
Y3 (mm)	3
Y4 (mm)	6
X (mm)	5.5
X1 (mm)	9
X2 (mm)	5.0
J (mm)	44
K	M5