

Series QCTF-QCBF - Cylinders with integrated guide

Product code: QCTF2A040C025

Datasheet creation date: 09/03/2025 22:58

Check the most updated document online [click here](#)



TECHNICAL DATA

Series (mm)	QC
Diameter (mm)	40
Type of bearing	T = sintered bronze bushes
Version	F = body mounted with moving flanges
Operation	2 = double - acting
Materials	A = anodized aluminium body rolled stainless steel 303 piston rod rolled stainless steel 420B columns for QTC
Cushion	C = one shock absorber located on the rear flange
Stroke type	standard
Stroke (mm)	25

Series QCTF-QCBF - Cylinders with integrated guide

Product code: QCTF2A040C025

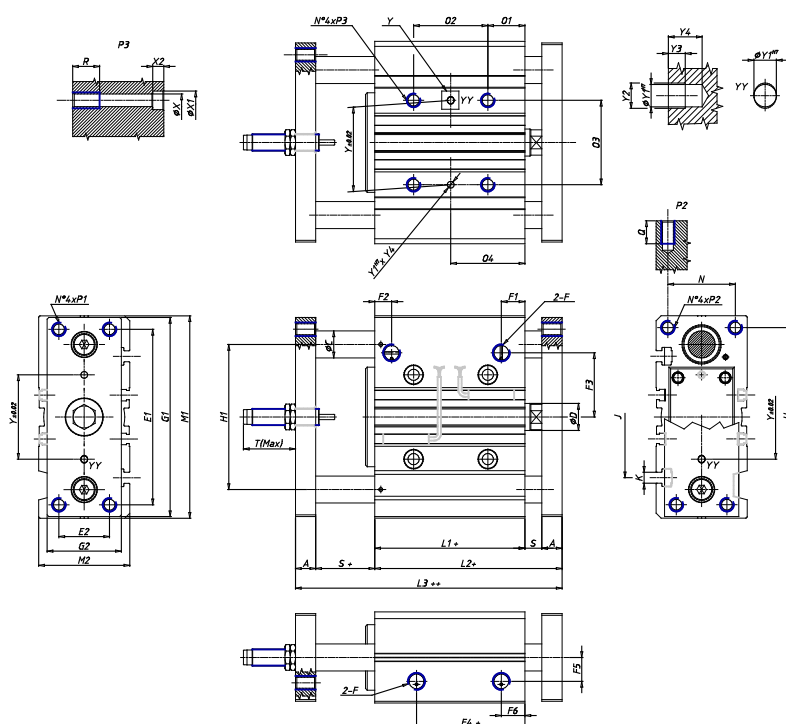

DIMENSIONS

C (mm)	16
O2 (mm)	24
O4 (mm)	34
A (mm)	12
D (mm)	16
E1 (mm)	104
E2 (mm)	30
F	G 1/8
F1 (mm)	13.0
F2 (mm)	12.0
F3 (mm)	38.0
F4 (mm)	13.0
F5 (mm)	18.0
F6 (mm)	13.0
G1 (mm)	118
G2 (mm)	45
G3 (mm)	-
H (mm)	106
H1 (mm)	86
L1 (mm)	44.0
L2 (mm)	66.0
L3 (mm)	88.0
M1 (mm)	120

M2 (mm)	54
N (mm)	40
O1 (mm)	22
O3 (mm)	50
P1	M8x1.25
P2	M8x1.25
P3	M8x1.25
Q (mm)	20
R (mm)	16
S (mm)	10
T (mm)	55
U (mm)	-
Y (mm)	50
Y1 (mm)	4
Y2 (mm)	4.5
Y3 (mm)	3
Y4 (mm)	6
X (mm)	6.5
X1 (mm)	11
X2 (mm)	6.5
J (mm)	72
K	M6