

Short-stroke cylinders - Series QL

Product code: QLM2A020A035

Datasheet creation date: 09/03/2025 23:14

Check the most updated document online [click here](#)



TECHNICAL DATA

| | |
|--------------------------|---|
| Series | QL |
| Version | M = Magnetic |
| Function | 2 = double - acting |
| Materials | A = rolled stainless steel rod - AL profile |
| Construction type | A = Standard |
| Diameter (mm) | Ø20 |
| Stroke (mm) | 35 |
| Rod | = Standard |
| Certification | = Standard |

Short-stroke cylinders - Series QL

Product code: QLM2A020A035

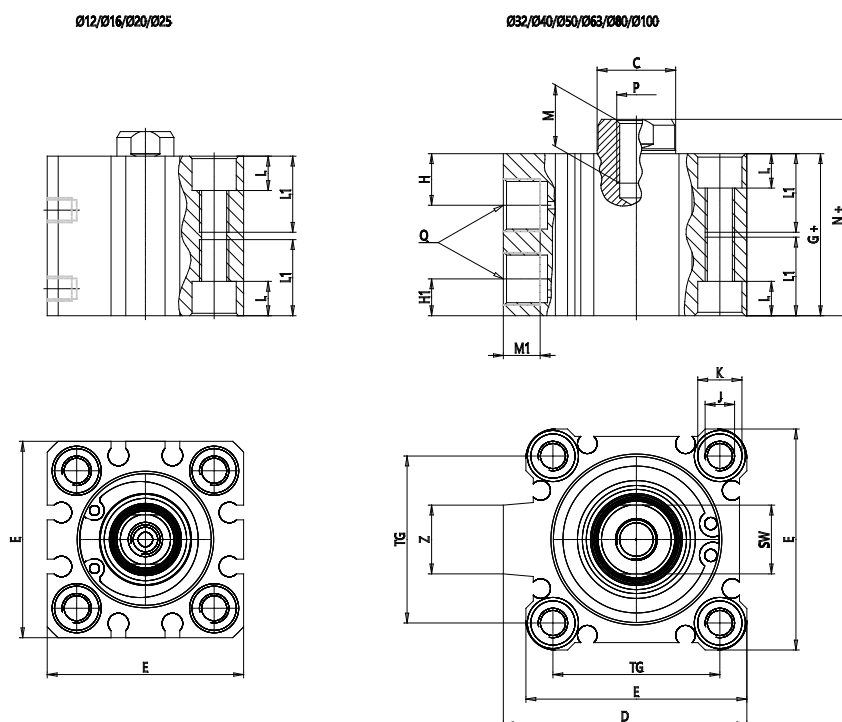

DIMENSIONS

| | |
|---------|---------|
| C (mm) | 10 |
| D (mm) | 0.0 |
| E (mm) | 35.5 |
| G (mm) | 31.5 |
| H (mm) | 8.0 |
| H1 (mm) | 5.5 |
| J | M6x1 |
| K (mm) | 9.0 |
| L (mm) | 7.0 |
| L1 (mm) | 17.0 |
| M (mm) | 7 |
| M1 (mm) | 6.0 |
| N (mm) | 36.0 |
| P | M5x0.8 |
| Q | M5x0.8 |
| SW (mm) | 8 |
| TG (mm) | 25.5 |
| Z (mm) | 0 |
| W (mm) | 18.5 |
| KK | M8x1.25 |
| AM (mm) | 14.0 |