

Short-stroke cylinders - Series QL

Product code: QLM2A025A005

Datasheet creation date: 09/03/2025 23:14

Check the most updated document online [click here](#)



TECHNICAL DATA

Series	QL
Version	M = Magnetic
Function	2 = double - acting
Materials	A = rolled stainless steel rod - AL profile
Construction type	A = Standard
Diameter (mm)	Ø25
Stroke (mm)	5
Rod	= Standard
Certification	= Standard

Short-stroke cylinders - Series QL

Product code: QLM2A025A005

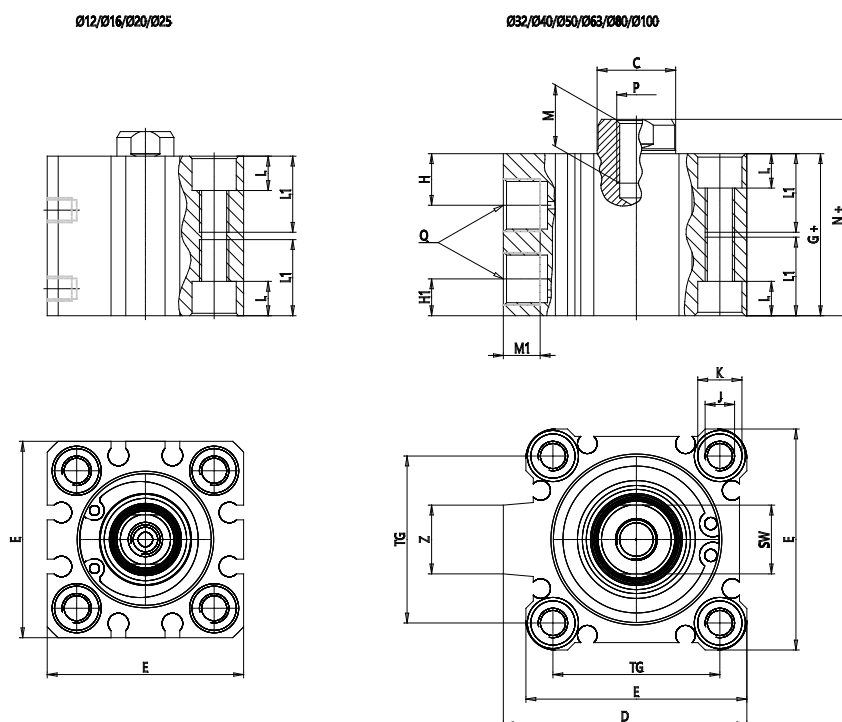

DIMENSIONS

C (mm)	12
D (mm)	0.0
E (mm)	40.0
G (mm)	32.5
H (mm)	11.0
H1 (mm)	5.5
J	M6x1
K (mm)	9.0
L (mm)	7.0
L1 (mm)	17.0
M (mm)	12
M1 (mm)	6.0
N (mm)	37.5
P	M6x1
Q	M5x0.8
SW (mm)	10
TG (mm)	28.0
Z (mm)	0
W (mm)	22.5
KK	M10x1.25
AM (mm)	17.5