

## Short-stroke cylinders - Series QL

Product code: QLM2A040A025

Datasheet creation date: 09/03/2025 23:17

Check the most updated document online [click here](#)



### TECHNICAL DATA

<b>Series</b>	QL
<b>Version</b>	M = Magnetic
<b>Function</b>	2 = double - acting
<b>Materials</b>	A = rolled stainless steel rod - AL profile
<b>Construction type</b>	A = Standard
<b>Diameter (mm)</b>	Ø40
<b>Stroke (mm)</b>	25
<b>Rod</b>	= Standard
<b>Certification</b>	= Standard

## Short-stroke cylinders - Series QL

Product code: QLM2A040A025

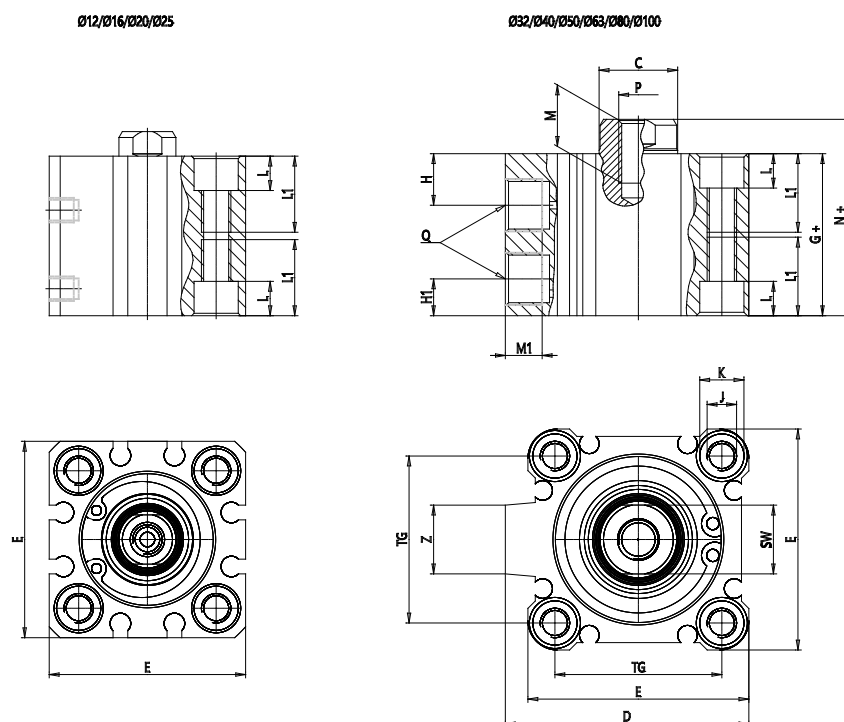

### DIMENSIONS

C (mm)	16
D (mm)	57.0
E (mm)	52.0
G (mm)	39.5
H (mm)	11.0
H1 (mm)	8.0
J	M6x1
K (mm)	9.0
L (mm)	7.0
L1 (mm)	17.0
M (mm)	13
M1 (mm)	7.5
N (mm)	46.5
P	M8x1.25
Q	G1/8
SW (mm)	14
TG (mm)	40.0
Z (mm)	15
W (mm)	30.5
KK	M14x1.5
AM (mm)	23.5