

Short-stroke cylinders - Series QL

Product code: QLM2A063A050

Datasheet creation date: 09/03/2025 23:19

Check the most updated document online [click here](#)



TECHNICAL DATA

Series	QL
Version	M = Magnetic
Function	2 = double - acting
Materials	A = rolled stainless steel rod - AL profile
Construction type	A = Standard
Diameter (mm)	Ø63
Stroke (mm)	50
Rod	= Standard
Certification	= Standard

Short-stroke cylinders - Series QL

Product code: QLM2A063A050

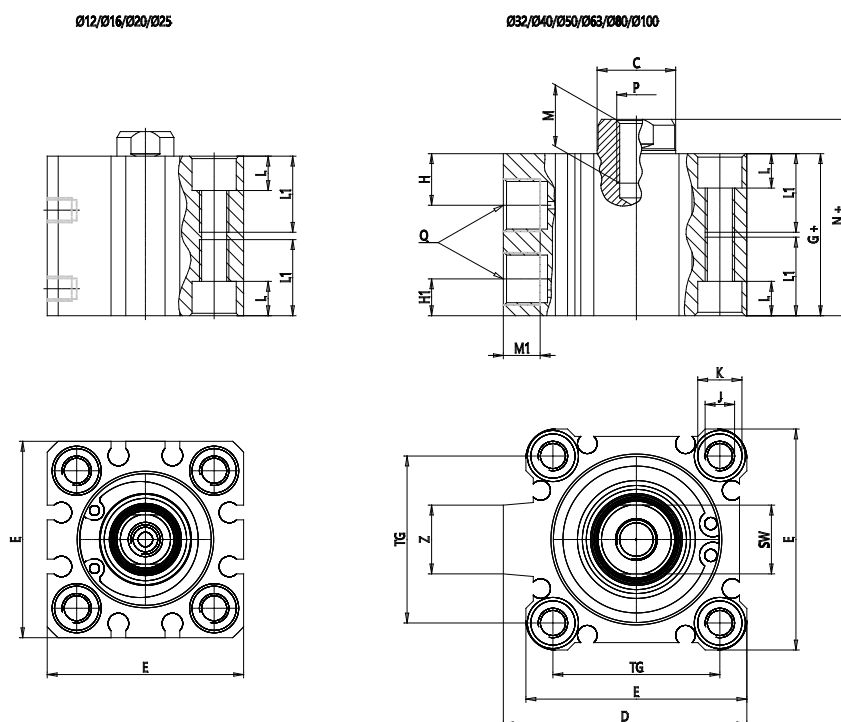

DIMENSIONS

C (mm)	20
D (mm)	84.0
E (mm)	77.0
G (mm)	46.0
H (mm)	15.0
H1 (mm)	10.5
J	M10x1.5
K (mm)	14.0
L (mm)	10.5
L1 (mm)	28.5
M (mm)	15
M1 (mm)	8.5
N (mm)	54.0
P	M10x1.5
Q	G1/4
SW (mm)	17
TG (mm)	60.0
Z (mm)	19
W (mm)	36.5
KK	M18x1.5
AM (mm)	28.5