

Short-stroke cylinders - Series QL

Product code: QLM2A100A045

Datasheet creation date: 09/03/2025 23:12

Check the most updated document online [click here](#)



TECHNICAL DATA

Series	QL
Version	M = Magnetic
Function	2 = double - acting
Materials	A = rolled stainless steel rod - AL profile
Construction type	A = Standard
Diameter (mm)	Ø100
Stroke (mm)	45
Rod	= Standard
Certification	= Standard

Short-stroke cylinders - Series QL

Product code: QLM2A100A045

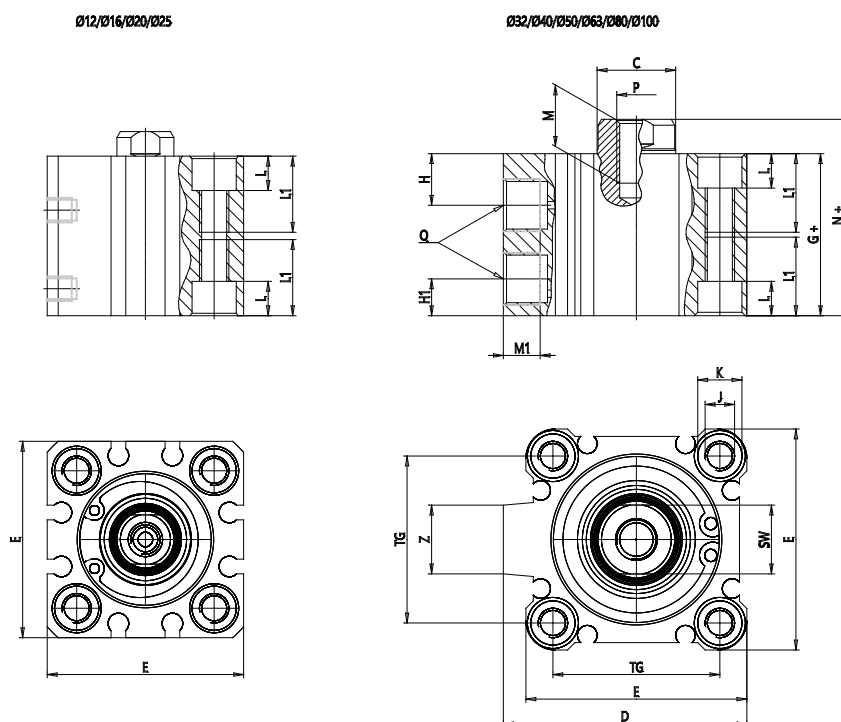

DIMENSIONS

C (mm)	32
D (mm)	123.5
E (mm)	117.0
G (mm)	63.0
H (mm)	20.5
H1 (mm)	13.0
J	M12x1.75
K (mm)	17.5
L (mm)	13.5
L1 (mm)	35.5
M (mm)	27
M1 (mm)	11.0
N (mm)	75.0
P	M20x2.5
Q	G3/8
SW (mm)	27
TG (mm)	94.0
Z (mm)	25
W (mm)	47.5
KK	M26x1.5
AM (mm)	35.5