

Short-stroke cylinders - Series QL

Product code: QLM3A012A015

Datasheet creation date: 09/03/2025 23:13

Check the most updated document online [click here](#)



TECHNICAL DATA

Series	QL
Version	M = Magnetic
Function	3 = double acting, through rod
Materials	A = rolled stainless steel rod - AL profile
Construction type	A = Standard
Diameter (mm)	Ø12
Stroke (mm)	15
Rod	= Standard
Certification	= Standard

Short-stroke cylinders - Series QL

Product code: QLM3A012A015

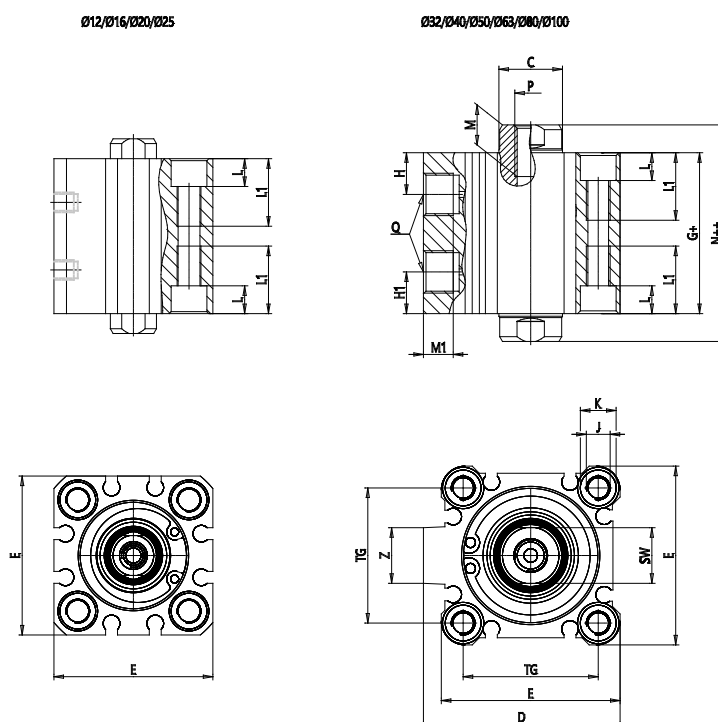

DIMENSIONS

C (mm)	6
D (mm)	0.0
E (mm)	25.0
G (mm)	32.4
H (mm)	7.5
H1 (mm)	7.5
J	M4x0.7
K (mm)	6.5
L (mm)	3.5
L1 (mm)	11.0
M (mm)	6
M1 (mm)	6.0
N (mm)	39.4
P	M3x0.5
Q	M5x0.8
SW (mm)	5
TG (mm)	15.5
Z (mm)	0
W (mm)	14.0
KK	M5x0.8
AM (mm)	10.5