

## Short-stroke cylinders - Series QL

Product code: QLM3A020A050

Datasheet creation date: 09/03/2025 23:14

Check the most updated document online [click here](#)



### TECHNICAL DATA

<b>Series</b>	QL
<b>Version</b>	M = Magnetic
<b>Function</b>	3 = double acting, through rod
<b>Materials</b>	A = rolled stainless steel rod - AL profile
<b>Construction type</b>	A = Standard
<b>Diameter (mm)</b>	Ø20
<b>Stroke (mm)</b>	50
<b>Rod</b>	= Standard
<b>Certification</b>	= Standard

## Short-stroke cylinders - Series QL

Product code: QLM3A020A050

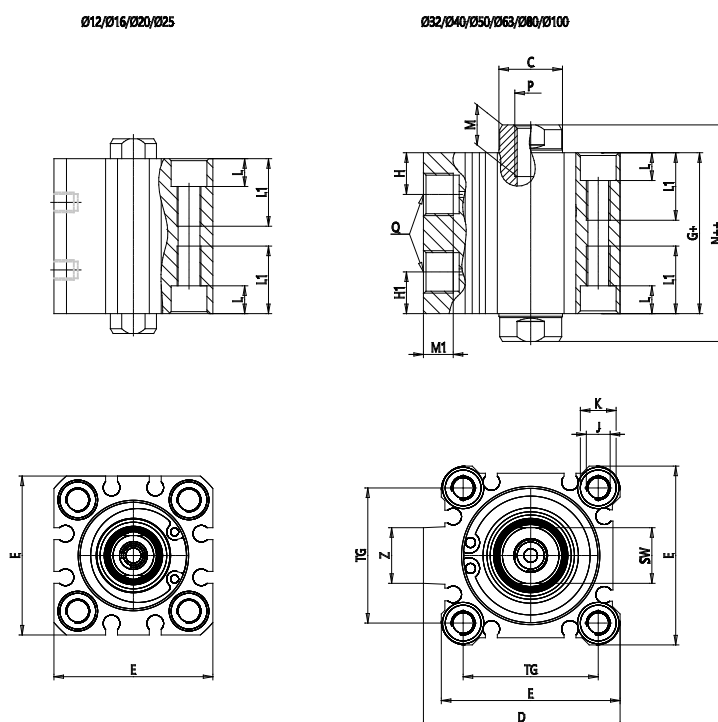

### DIMENSIONS

C (mm)	10
D (mm)	0.0
E (mm)	35.5
G (mm)	38.0
H (mm)	8.0
H1 (mm)	8.0
J	M6x1
K (mm)	9.0
L (mm)	7.0
L1 (mm)	17.0
M (mm)	7
M1 (mm)	6.0
N (mm)	47.0
P	M5x0.8
Q	M5x0.8
SW (mm)	8
TG (mm)	25.5
Z (mm)	0
W (mm)	18.5
KK	M8x1.25
AM (mm)	14.0