

Short-stroke cylinders - Series QL

Product code: QLM3A032A040

Datasheet creation date: 09/03/2025 23:17

Check the most updated document online [click here](#)



TECHNICAL DATA

Series	QL
Version	M = Magnetic
Function	3 = double acting, through rod
Materials	A = rolled stainless steel rod - AL profile
Construction type	A = Standard
Diameter (mm)	Ø32
Stroke (mm)	40
Rod	= Standard
Certification	= Standard

Short-stroke cylinders - Series QL

Product code: QLM3A032A040

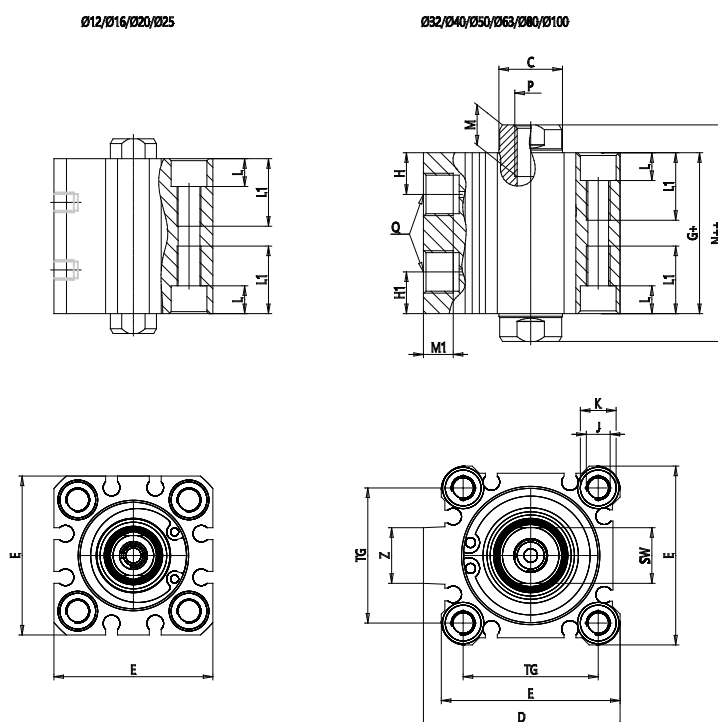

DIMENSIONS

C (mm)	16
D (mm)	49.5
E (mm)	45.0
G (mm)	40.5
H (mm)	10.5
H1 (mm)	10.5
J	M6x1
K (mm)	9.0
L (mm)	7.0
L1 (mm)	17.0
M (mm)	13
M1 (mm)	7.5
N (mm)	54.5
P	M8x1.25
Q	G1/8
SW (mm)	14
TG (mm)	34.0
Z (mm)	14
W (mm)	30.5
KK	M14x1.5
AM (mm)	23.5