

## Short-stroke cylinders - Series QL

Product code: QLN2A025A030

Datasheet creation date: 09/03/2025 23:24

Check the most updated document online [click here](#)



### TECHNICAL DATA

<b>Series</b>	QL
<b>Version</b>	N = Non magnetic
<b>Function</b>	2 = double - acting
<b>Materials</b>	A = rolled stainless steel rod - AL profile
<b>Construction type</b>	A = Standard
<b>Diameter (mm)</b>	Ø25
<b>Stroke (mm)</b>	30
<b>Rod</b>	= Standard
<b>Certification</b>	= Standard

## Short-stroke cylinders - Series QL

Product code: QLN2A025A030

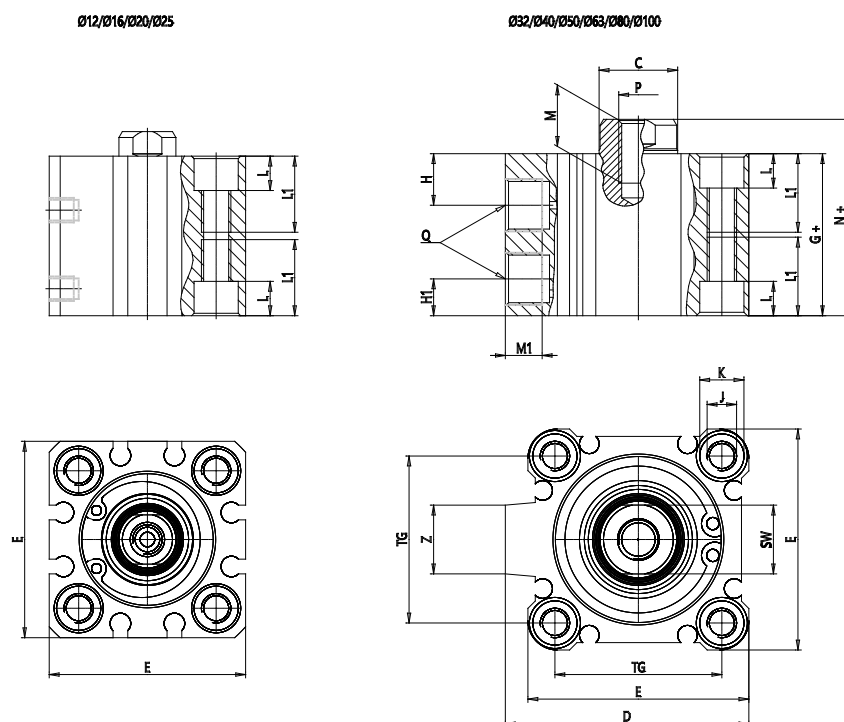

### DIMENSIONS

C (mm)	12
D (mm)	0.0
E (mm)	40.0
G (mm)	22.5
H (mm)	11.0
H1 (mm)	5.5
J	M6x1
K (mm)	9.0
L (mm)	7.0
L1 (mm)	17.0
M (mm)	12
M1 (mm)	6.0
N (mm)	27.5
P	M6x1
Q	M5x0.8
SW (mm)	10
TG (mm)	28.0
Z (mm)	0
W (mm)	22.5
KK	M10x1.25
AM (mm)	17.5