

Short-stroke cylinders - Series QL

Product code: QLN2A040A075

Datasheet creation date: 09/03/2025 23:26

Check the most updated document online [click here](#)



TECHNICAL DATA

Series	QL
Version	N = Non magnetic
Function	2 = double - acting
Materials	A = rolled stainless steel rod - AL profile
Construction type	A = Standard
Diameter (mm)	Ø40
Stroke (mm)	75
Rod	= Standard
Certification	= Standard

Short-stroke cylinders - Series QL

Product code: QLN2A040A075

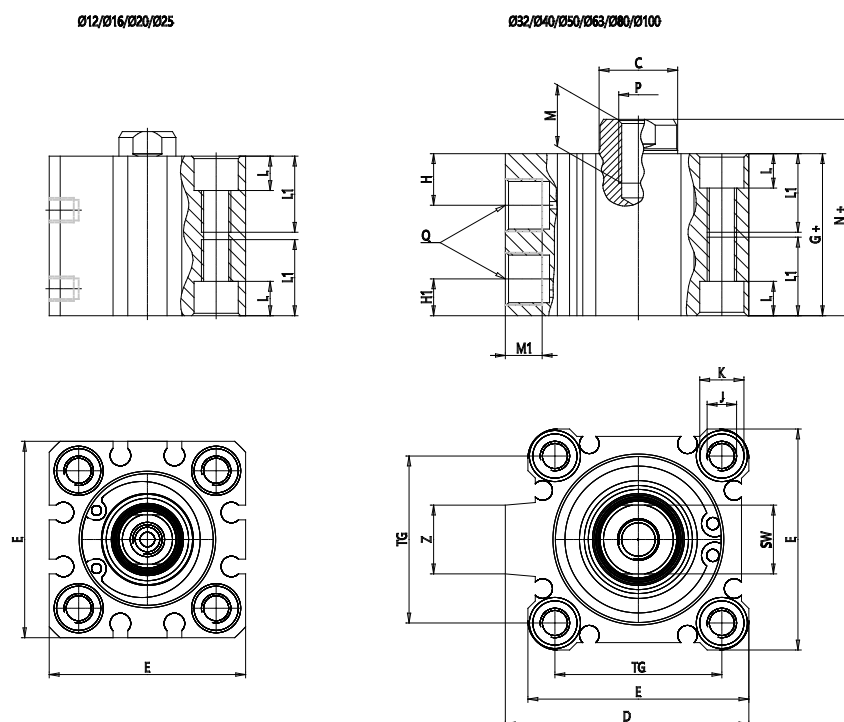

DIMENSIONS

C (mm)	16
D (mm)	57.0
E (mm)	52.0
G (mm)	39.5
H (mm)	11.0
H1 (mm)	8.0
J	M6x1
K (mm)	9.0
L (mm)	7.0
L1 (mm)	17.0
M (mm)	13
M1 (mm)	7.5
N (mm)	46.5
P	M8x1.25
Q	G1/8
SW (mm)	14
TG (mm)	40.0
Z (mm)	15
W (mm)	30.5
KK	M14x1.5
AM (mm)	23.5