

Short-stroke cylinders - Series QL

Product code: QLN2A050A045

Datasheet creation date: 09/03/2025 23:26

Check the most updated document online [click here](#)



TECHNICAL DATA

Series	QL
Version	N = Non magnetic
Function	2 = double - acting
Materials	A = rolled stainless steel rod - AL profile
Construction type	A = Standard
Diameter (mm)	Ø50
Stroke (mm)	45
Rod	= Standard
Certification	= Standard

Short-stroke cylinders - Series QL

Product code: QLN2A050A045

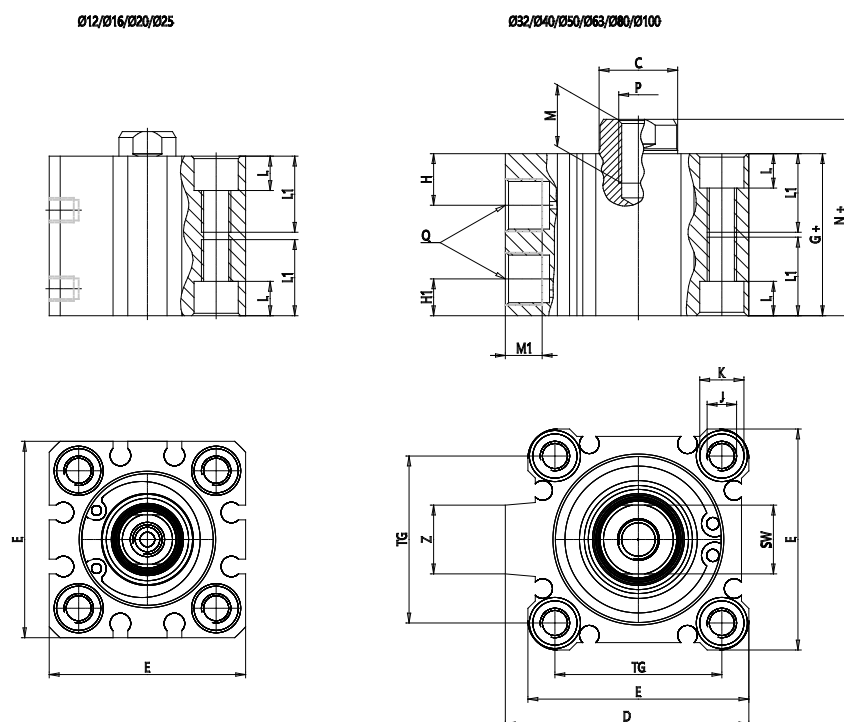

DIMENSIONS

C (mm)	20
D (mm)	71.0
E (mm)	64.0
G (mm)	30.5
H (mm)	10.5
H1 (mm)	10.5
J	M8x1.25
K (mm)	11.0
L (mm)	8.0
L1 (mm)	22.0
M (mm)	15
M1 (mm)	8.5
N (mm)	38.5
P	M10x1.5
Q	G1/4
SW (mm)	17
TG (mm)	50.0
Z (mm)	19
W (mm)	36.5
KK	M18x1.5
AM (mm)	28.5