

## Short-stroke cylinders - Series QL

Product code: QLN2A063A025

Datasheet creation date: 09/03/2025 23:27

Check the most updated document online [click here](#)



### TECHNICAL DATA

<b>Series</b>	QL
<b>Version</b>	N = Non magnetic
<b>Function</b>	2 = double - acting
<b>Materials</b>	A = rolled stainless steel rod - AL profile
<b>Construction type</b>	A = Standard
<b>Diameter (mm)</b>	Ø63
<b>Stroke (mm)</b>	25
<b>Rod</b>	= Standard
<b>Certification</b>	= Standard

## Short-stroke cylinders - Series QL

Product code: QLN2A063A025

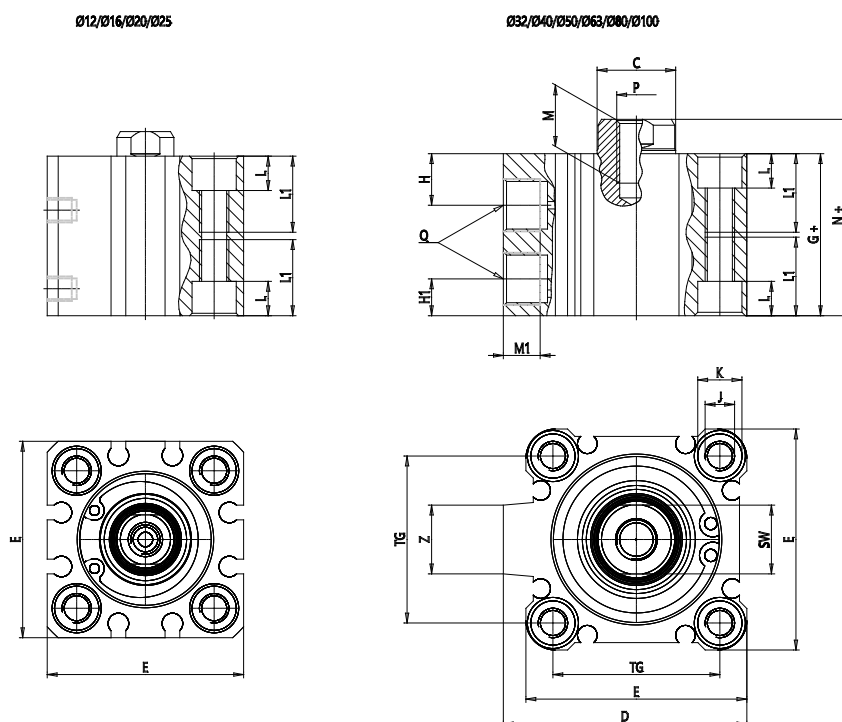

### DIMENSIONS

C (mm)	20
D (mm)	84.0
E (mm)	77.0
G (mm)	36.0
H (mm)	15.0
H1 (mm)	10.5
J	M10x1.5
K (mm)	14.0
L (mm)	10.5
L1 (mm)	28.5
M (mm)	15
M1 (mm)	8.5
N (mm)	44.0
P	M10x1.5
Q	G1/4
SW (mm)	17
TG (mm)	60.0
Z (mm)	19
W (mm)	36.5
KK	M18x1.5
AM (mm)	28.5