

Short-stroke cylinders - Series QL

Product code: QLN2A080A075

Datasheet creation date: 07/03/2025 14:32

Check the most updated document online [click here](#)



TECHNICAL DATA

Series	QL
Version	N = Non magnetic
Function	2 = double - acting
Materials	A = rolled stainless steel rod - AL profile
Construction type	A = Standard
Diameter (mm)	Ø80
Stroke (mm)	75
Rod	= Standard
Certification	= Standard

Short-stroke cylinders - Series QL

Product code: QLN2A080A075

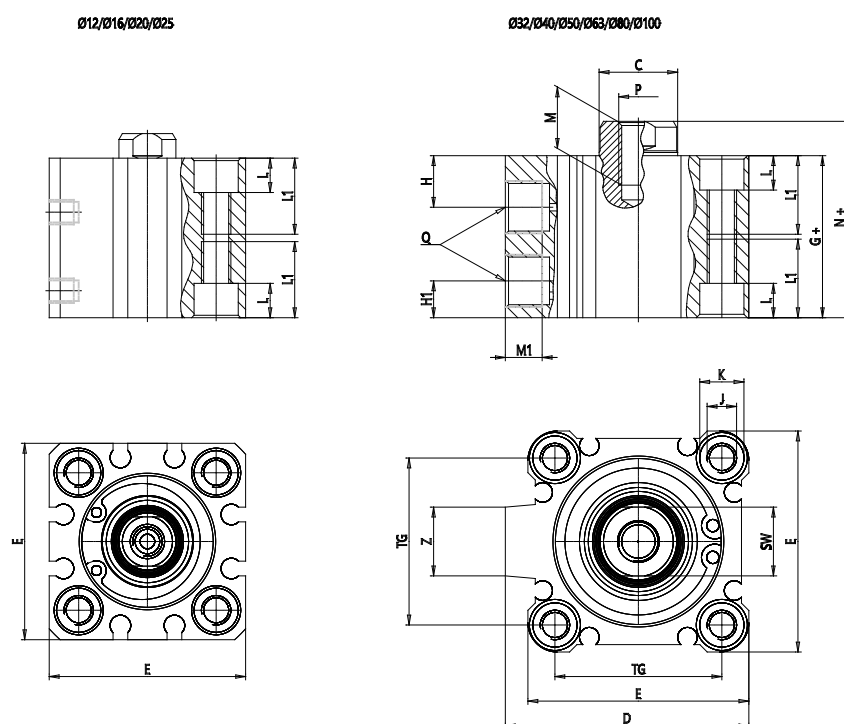

DIMENSIONS

C (mm)	25
D (mm)	104.0
E (mm)	98.0
G (mm)	53.5
H (mm)	15.0
H1 (mm)	12.5
J	M12x1.75
K (mm)	17.5
L (mm)	13.5
L1 (mm)	35.5
M (mm)	21
M1 (mm)	11.0
N (mm)	63.5
P	M16x2
Q	G3/8
SW (mm)	22
TG (mm)	77.0
Z (mm)	25
W (mm)	45.5
KK	M22x1.5
AM (mm)	35.5