

Series QN - Short-stroke cylinders

Product code: QN1A20A04

Datasheet creation date: 10/03/2025 00:22

Check the most updated document online [click here](#)



TECHNICAL DATA

SERIE (Series)	QN
FUNZIONE (Funzionamento)	1 = semplice effetto
MATERIALI (Materiali)	A = stelo acciaio INOX rullato - corpo AL
PHY (Diameter / mm)	20
TIPOCOSTRUT (Tipo costruttivo)	A = standard
HUB (Stroke / mm)	4

Series QN - Short-stroke cylinders

Product code: QN1A20A04

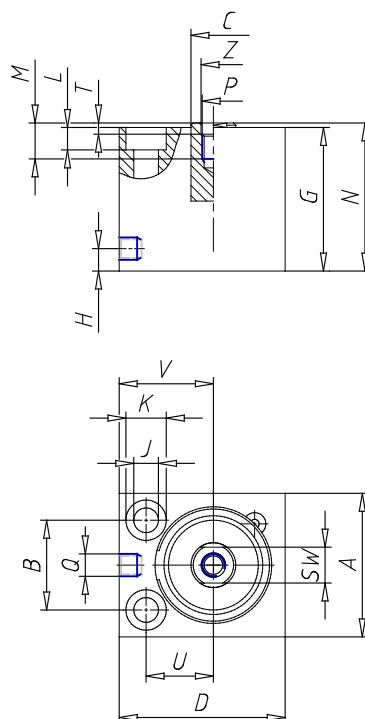

DIMENSIONS

A (mm)	32
B (mm)	20
Ø C (mm)	10
D (mm)	37
E (mm)	37.0
F (mm)	-
G (mm)	20.0
H (mm)	5.0
Ø J (mm)	5.5
Ø K (mm)	9.0
L (mm)	5.0
M (mm)	8
N (mm)	21.0
P	M5
Q	M5
R (mm)	-
SW (mm)	8
T (mm)	2.5
U (mm)	15
V (mm)	21.0
Z (mm)	5.5