

Short stroke magnetic cylinders - Series QP-QPR

Product code: QP2A016A032

Datasheet creation date: 09/03/2025 23:43

Check the most updated document online [click here](#)



TECHNICAL DATA

Series	QP = standard
Diameter (mm)	16
Operation	2=double-acting
Materials	A = rolled stainless steel
Construction	A = standard
Stroke type	= variable
Stroke (mm)	32
Atex	No Atex
Rod lenght (mm)	0

Short stroke magnetic cylinders - Series QP-QPR

Product code: QP2A016A032

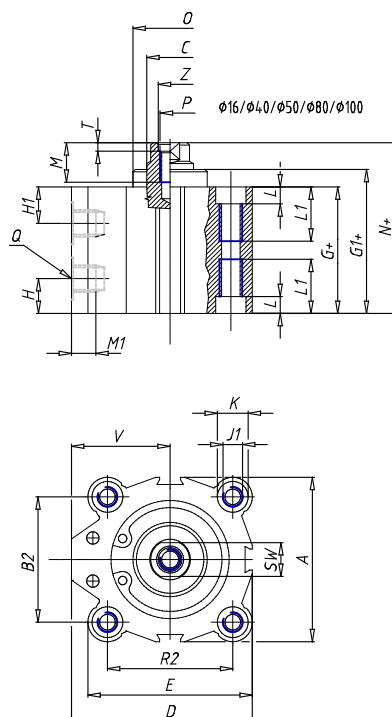

DIMENSIONS

A (mm)	29.0
B (mm)	20.0
B1 (mm)	-
B2 (mm)	-
Ø C (mm)	8
D (mm)	29.00
E (mm)	29.00
G (mm)	32.0
G1 (mm)	32.4
H1 (mm)	10.9
H (mm)	8.7
J (mm)	3.5
J1	-
K (mm)	5.8
L (mm)	3.0
L1 (mm)	-
M (mm)	8.0
M1 (mm)	4.5
N (mm)	36.4
N1 (mm)	-
Ø O (mm)	16.6
P	M4
Q	M5

R (mm)	20.0
R1 (mm)	-
R2 (mm)	-
SW (mm)	6
T (mm)	-
U (mm)	-
V (mm)	14.50
AA (mm)	5
BB (mm)	3.5
Ø CC (mm)	6.2
Ø DD (mm)	3.2
EE (mm)	6.5
FF	M3
LL (mm)	20.0
MM (mm)	28.0
NN (mm)	28
RR (mm)	20.0
VV (mm)	-
Z (mm)	-