

Short stroke magnetic cylinders - Series QP-QPR

Product code: QP2A025A018

Datasheet creation date: 09/03/2025 23:48

Check the most updated document online [click here](#)



TECHNICAL DATA

| | |
|------------------------|----------------------------|
| Series | QP = standard |
| Diameter (mm) | 25 |
| Operation | 2=double-acting |
| Materials | A = rolled stainless steel |
| Construction | A = standard |
| Stroke type | = variable |
| Stroke (mm) | 18 |
| Atex | No Atex |
| Rod lenght (mm) | 0 |

Short stroke magnetic cylinders - Series QP-QPR

Product code: QP2A025A018

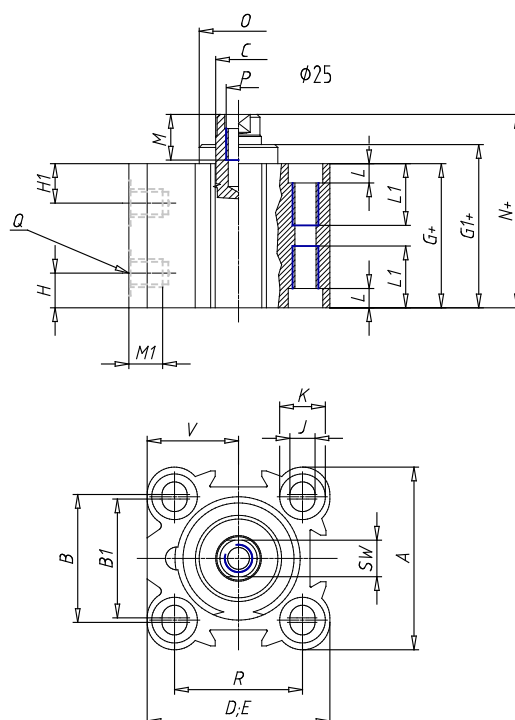

DIMENSIONS

| | |
|----------|-------|
| A (mm) | 40.0 |
| B (mm) | 28.0 |
| B1 (mm) | 26 |
| B2 (mm) | - |
| Ø C (mm) | 10 |
| D (mm) | 40.00 |
| E (mm) | 40.00 |
| G (mm) | 32.1 |
| G1 (mm) | 33.5 |
| H1 (mm) | 8.0 |
| H (mm) | 6.9 |
| J (mm) | 5.5 |
| J1 | - |
| K (mm) | 10.0 |
| L (mm) | 5.5 |
| L1 (mm) | - |
| M (mm) | 8.0 |
| M1 (mm) | 4.5 |
| N (mm) | 37.5 |
| N1 (mm) | - |
| Ø O (mm) | 22.0 |
| P | M6 |
| Q | M5 |

| | |
|-----------|-------|
| R (mm) | 28.0 |
| R1 (mm) | - |
| R2 (mm) | - |
| SW (mm) | 8 |
| T (mm) | - |
| U (mm) | - |
| V (mm) | 20.00 |
| AA (mm) | 10 |
| BB (mm) | 4.6 |
| Ø CC (mm) | 8.0 |
| Ø DD (mm) | 4.2 |
| EE (mm) | 10.0 |
| FF | M4 |
| LL (mm) | 27.0 |
| MM (mm) | 40.0 |
| NN (mm) | 40 |
| RR (mm) | 28.0 |
| VV (mm) | - |
| Z (mm) | - |