

Short stroke magnetic cylinders - Series QP-QPR

Product code: QP2A040A010V

Datasheet creation date: 09/03/2025 23:55

Check the most updated document online [click here](#)



TECHNICAL DATA

Series	QP = standard
Diameter (mm)	40
Operation	2=double-acting
Materials	A = rolled stainless steel
Construction	A = standard
Stroke type	N = standard
Stroke (mm)	10
Atex	No Atex
Rod lenght (mm)	0

Short stroke magnetic cylinders - Series QP-QPR

Product code: QP2A040A010V

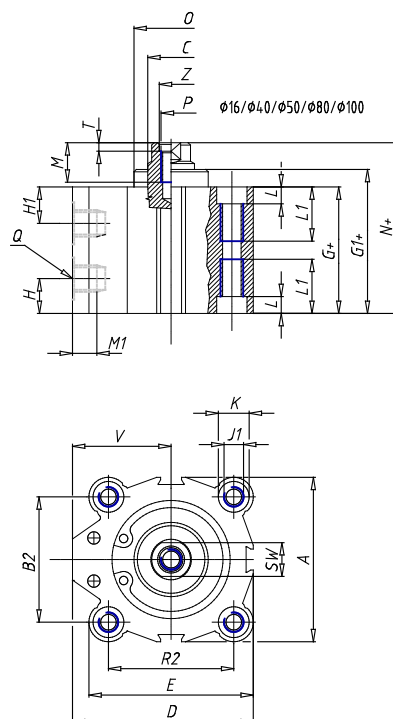

DIMENSIONS

A (mm)	52.0
B (mm)	-
B1 (mm)	-
B2 (mm)	40
Ø C (mm)	16
D (mm)	57.00
E (mm)	52.00
G (mm)	42.4
G1 (mm)	43.4
H1 (mm)	10.7
H (mm)	10.7
J (mm)	5.5
J1	M8
K (mm)	9.0
L (mm)	6.0
L1 (mm)	21.0
M (mm)	13.5
M1 (mm)	7.5
N (mm)	47.9
N1 (mm)	-
Ø O (mm)	29.6
P	M8
Q	G1/8

R (mm)	-
R1 (mm)	-
R2 (mm)	40
SW (mm)	13
T (mm)	3.5
U (mm)	-
V (mm)	31.00
AA (mm)	10
BB (mm)	6.0
Ø CC (mm)	9.0
Ø DD (mm)	5.5
EE (mm)	9.0
FF	M5
LL (mm)	40.0
MM (mm)	52.0
NN (mm)	50
RR (mm)	40.0
VV (mm)	-
Z (mm)	8.5