

Short stroke magnetic cylinders - Series QP-QPR

Product code: QP2A050A035V

Datasheet creation date: 10/03/2025 00:00

Check the most updated document online [click here](#)



TECHNICAL DATA

Series	QP = standard
Diameter (mm)	50
Operation	2=double-acting
Materials	A = rolled stainless steel
Construction	A = standard
Stroke type	N = standard
Stroke (mm)	35
Atex	No Atex
Rod lenght (mm)	0

Short stroke magnetic cylinders - Series QP-QPR

Product code: QP2A050A035V

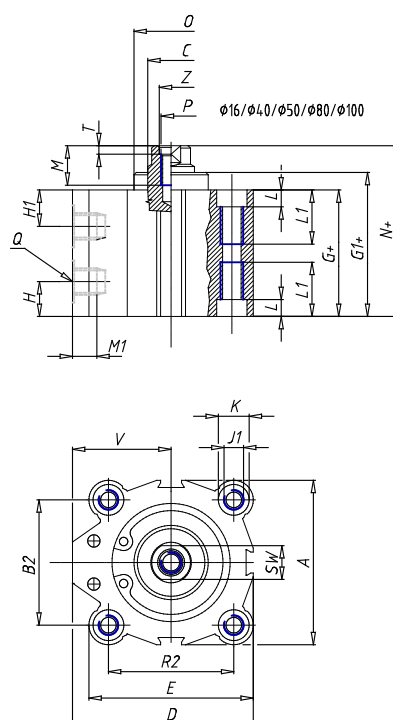

DIMENSIONS

A (mm)	64.0
B (mm)	-
B1 (mm)	-
B2 (mm)	50
Ø C (mm)	16
D (mm)	72.00
E (mm)	64.00
G (mm)	42.2
G1 (mm)	44
H1 (mm)	11.2
H (mm)	11.2
J (mm)	6.5
J1	M8
K (mm)	10.5
L (mm)	6.0
L1 (mm)	21.0
M (mm)	13.5
M1 (mm)	9.0
N (mm)	48.4
N1 (mm)	-
Ø O (mm)	37.5
P	M8
Q	G1/4

R (mm)	-
R1 (mm)	-
R2 (mm)	50
SW (mm)	13
T (mm)	3.5
U (mm)	-
V (mm)	40.00
AA (mm)	12
BB (mm)	6.8
Ø CC (mm)	10.5
Ø DD (mm)	6.5
EE (mm)	10.0
FF	M6
LL (mm)	50.0
MM (mm)	65.0
NN (mm)	65
RR (mm)	50.0
VV (mm)	-
Z (mm)	8.5