

Short stroke magnetic cylinders - Series QP-QPR

Product code: QP2A080A100W

Datasheet creation date: 10/03/2025 00:08

Check the most updated document online [click here](#)



TECHNICAL DATA

Series	QP = standard
Diameter (mm)	80
Operation	2=double-acting
Materials	A = rolled stainless steel
Construction	A = standard
Stroke type	N = standard
Stroke (mm)	100
Atex	No Atex
Rod lenght (mm)	0

Short stroke magnetic cylinders - Series QP-QPR

Product code: QP2A080A100W

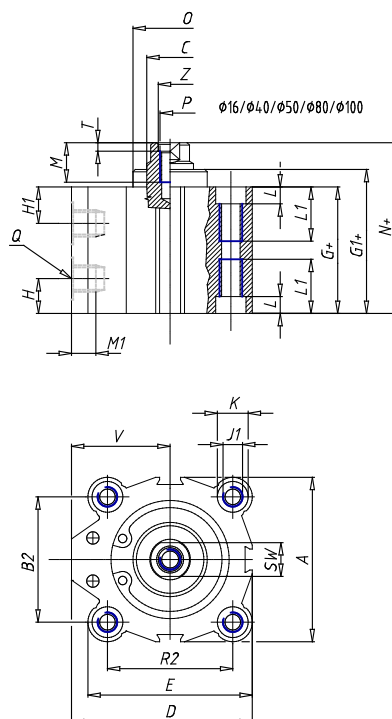

DIMENSIONS

A (mm)	98.0
B (mm)	-
B1 (mm)	-
B2 (mm)	77
Ø C (mm)	25
D (mm)	104.00
E (mm)	98.00
G (mm)	57.5
G1 (mm)	58.1
H1 (mm)	16.2
H (mm)	16.2
J (mm)	10.5
J1	M12
K (mm)	17.0
L (mm)	10.5
L1 (mm)	31.5
M (mm)	15.0
M1 (mm)	10.5
N (mm)	63.5
N1 (mm)	-
Ø O (mm)	62
P	M16
Q	G3/8

R (mm)	-
R1 (mm)	-
R2 (mm)	77
SW (mm)	22
T (mm)	4.0
U (mm)	-
V (mm)	55.00
AA (mm)	15
BB (mm)	10.0
Ø CC (mm)	16.5
Ø DD (mm)	11.0
EE (mm)	17.0
FF	M8
LL (mm)	77.0
MM (mm)	100.0
NN (mm)	100
RR (mm)	77.0
VV (mm)	-
Z (mm)	16.5