

Short stroke magnetic cylinders - Series QP-QPR

Product code: QP3A012A025

Datasheet creation date: 09/03/2025 23:42

Check the most updated document online [click here](#)



TECHNICAL DATA

Series	QP = standard
Diameter (mm)	12
Operation	3=double-acting through rod
Materials	A = rolled stainless steel
Construction	A = standard
Stroke type	N = standard
Stroke (mm)	25
Atex	No Atex
Rod lenght (mm)	0

Short stroke magnetic cylinders - Series QP-QPR

Product code: QP3A012A025

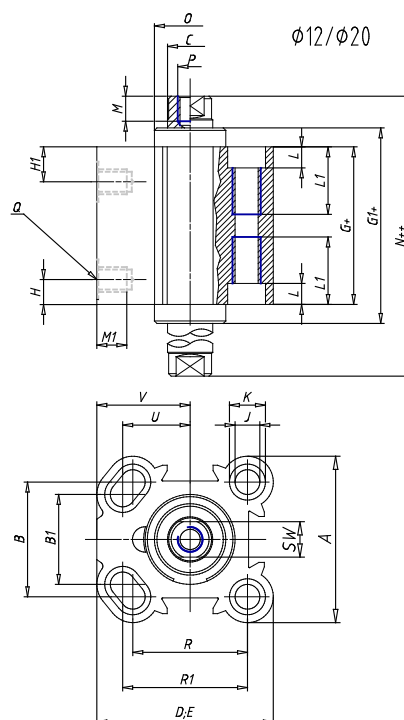

DIMENSIONS

A (mm)	23.8
B (mm)	15.5
B1 (mm)	13
B2 (mm)	-
Ø C (mm)	6
D (mm)	25.00
E (mm)	25.00
G (mm)	34.5
G1 (mm)	34.5
H1 (mm)	12.3
H (mm)	12.3
J (mm)	3.5
J1	-
K (mm)	5.8
L (mm)	3.0
L1 (mm)	-
M (mm)	5.5
M1 (mm)	4.5
N (mm)	43.9
N1 (mm)	-
Ø O (mm)	12
P	M3
Q	M5

R (mm)	15.5
R1 (mm)	16.75
R2 (mm)	-
SW (mm)	5
T (mm)	-
U (mm)	9
V (mm)	13.15
AA (mm)	5
BB (mm)	3.5
Ø CC (mm)	6.2
Ø DD (mm)	3.2
EE (mm)	5.8
FF	M3
LL (mm)	15.5
MM (mm)	25.0
NN (mm)	24
RR (mm)	15.5
VV (mm)	12
Z (mm)	-