

Short stroke magnetic cylinders - Series QP-QPR

Product code: QP3A025A003

Datasheet creation date: 09/03/2025 23:50

Check the most updated document online [click here](#)



TECHNICAL DATA

Series	QP = standard
Diameter (mm)	25
Operation	3=double-acting through rod
Materials	A = rolled stainless steel
Construction	A = standard
Stroke type	= variable
Stroke (mm)	3
Atex	No Atex
Rod lenght (mm)	0

Short stroke magnetic cylinders - Series QP-QPR

Product code: QP3A025A003

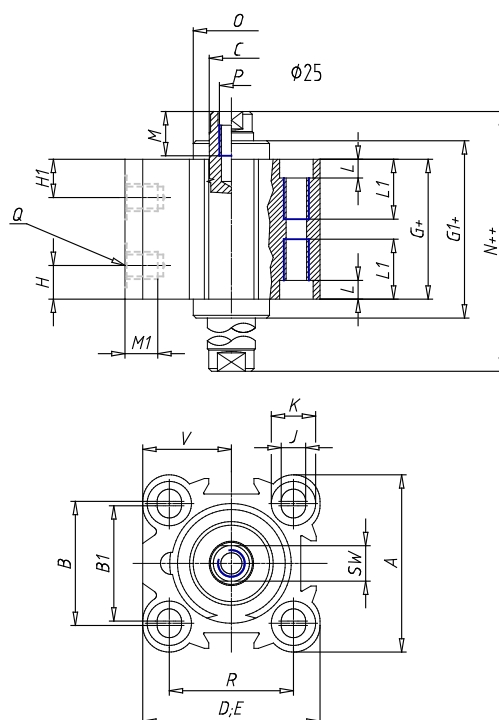

DIMENSIONS

A (mm)	40.0
B (mm)	28.0
B1 (mm)	26
B2 (mm)	-
Ø C (mm)	10
D (mm)	40.00
E (mm)	40.00
G (mm)	36.3
G1 (mm)	39.1
H1 (mm)	8.0
H (mm)	8.0
J (mm)	5.5
J1	-
K (mm)	10.0
L (mm)	5.5
L1 (mm)	-
M (mm)	8.0
M1 (mm)	4.5
N (mm)	47.1
N1 (mm)	-
Ø O (mm)	22.0
P	M6
Q	M5

R (mm)	28.0
R1 (mm)	-
R2 (mm)	-
SW (mm)	8
T (mm)	-
U (mm)	-
V (mm)	20.00
AA (mm)	10
BB (mm)	4.6
Ø CC (mm)	8.0
Ø DD (mm)	4.2
EE (mm)	10.0
FF	M4
LL (mm)	27.0
MM (mm)	40.0
NN (mm)	40
RR (mm)	28.0
VV (mm)	-
Z (mm)	-