

Short stroke magnetic cylinders - Series QP-QPR

Product code: QP3A032A025

Datasheet creation date: 09/03/2025 23:54

Check the most updated document online [click here](#)



TECHNICAL DATA

Series	QP = standard
Diameter (mm)	32
Operation	3=double-acting through rod
Materials	A = rolled stainless steel
Construction	A = standard
Stroke type	N = standard
Stroke (mm)	25
Atex	No Atex
Rod lenght (mm)	0

Short stroke magnetic cylinders - Series QP-QPR

Product code: QP3A032A025

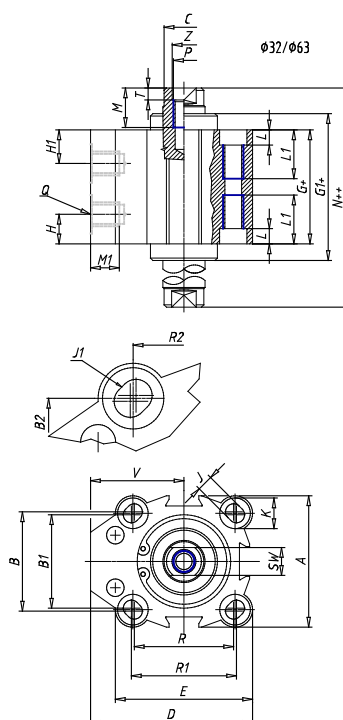

DIMENSIONS

A (mm)	45.0
B (mm)	34.0
B1 (mm)	32
B2 (mm)	33
Ø C (mm)	12
D (mm)	55.50
E (mm)	47.00
G (mm)	39.5
G1 (mm)	0
H1 (mm)	9.5
H (mm)	9.5
J (mm)	5.5
J1	M8
K (mm)	10.5
L (mm)	6.0
L1 (mm)	21.0
M (mm)	10.0
M1 (mm)	7.5
N (mm)	48.5
N1 (mm)	-
Ø O (mm)	23.5
P	M6
Q	G1/8

R (mm)	34.0
R1 (mm)	36.00
R2 (mm)	35
SW (mm)	10
T (mm)	2.5
U (mm)	-
V (mm)	32.00
AA (mm)	10
BB (mm)	6.0
Ø CC (mm)	9.0
Ø DD (mm)	5.5
EE (mm)	9.0
FF	M5
LL (mm)	32.0
MM (mm)	47.0
NN (mm)	45
RR (mm)	36.0
VV (mm)	-
Z (mm)	7.0