

Short stroke magnetic cylinders - Series QP-QPR

Product code: QP3A063A012

Datasheet creation date: 10/03/2025 00:06

Check the most updated document online [click here](#)



TECHNICAL DATA

Series	QP = standard
Diameter (mm)	63
Operation	3=double-acting through rod
Materials	A = rolled stainless steel
Construction	A = standard
Stroke type	= variable
Stroke (mm)	12
Atex	No Atex
Rod lenght (mm)	0

Short stroke magnetic cylinders - Series QP-QPR

Product code: QP3A063A012

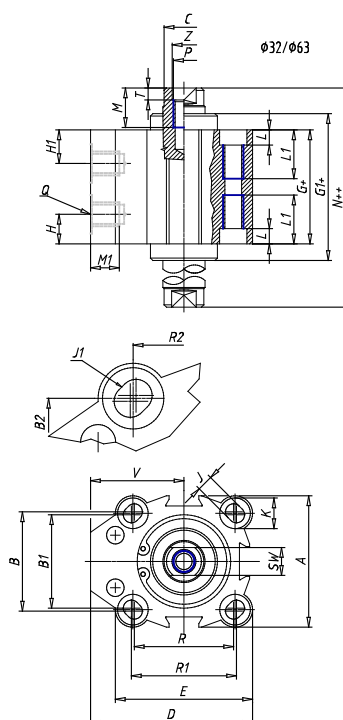

DIMENSIONS

A (mm)	80.0
B (mm)	62.0
B1 (mm)	60
B2 (mm)	61
$\varnothing C$ (mm)	20
D (mm)	88.00
E (mm)	80.00
G (mm)	49.5
G1 (mm)	0
H1 (mm)	13.0
H (mm)	13.0
J (mm)	8.5
J1	M12
K (mm)	15.0
L (mm)	8.5
L1 (mm)	31.5
M (mm)	13.5
M1 (mm)	9.0
N (mm)	58.5
N1 (mm)	-
$\varnothing O$ (mm)	50
P	M8
Q	G1/4

R (mm)	60.0
R1 (mm)	62.00
R2 (mm)	61
SW (mm)	17
T (mm)	4.0
U (mm)	-
V (mm)	48.00
AA (mm)	12
BB (mm)	8.5
$\varnothing CC$ (mm)	14.0
$\varnothing DD$ (mm)	9.0
EE (mm)	15.0
FF	M6
LL (mm)	62.0
MM (mm)	80.0
NN (mm)	80
RR (mm)	62.0
VV (mm)	-
Z (mm)	8.5