

## Short stroke magnetic cylinders - Series QP-QPR

Product code: QP3A063A090

Datasheet creation date: 10/03/2025 00:06

Check the most updated document online [click here](#)



### TECHNICAL DATA

<b>Series</b>	QP = standard
<b>Diameter (mm)</b>	63
<b>Operation</b>	3=double-acting through rod
<b>Materials</b>	A = rolled stainless steel
<b>Construction</b>	A = standard
<b>Stroke type</b>	= variable
<b>Stroke (mm)</b>	90
<b>Atex</b>	No Atex
<b>Rod lenght (mm)</b>	0

## Short stroke magnetic cylinders - Series QP-QPR

Product code: QP3A063A090

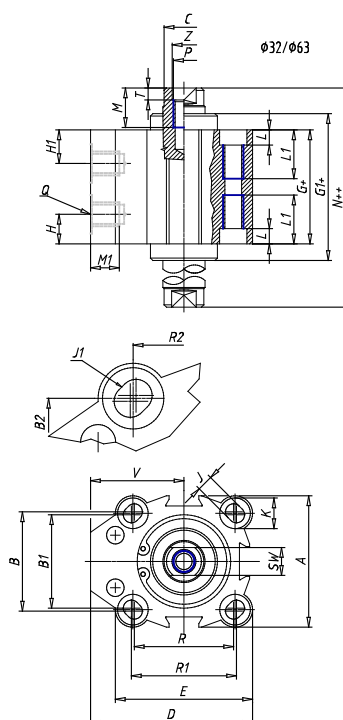

### DIMENSIONS

<b>A (mm)</b>	80.0
<b>B (mm)</b>	62.0
<b>B1 (mm)</b>	60
<b>B2 (mm)</b>	61
<b>Ø C (mm)</b>	20
<b>D (mm)</b>	88.00
<b>E (mm)</b>	80.00
<b>G (mm)</b>	49.5
<b>G1 (mm)</b>	0
<b>H1 (mm)</b>	13.0
<b>H (mm)</b>	13.0
<b>J (mm)</b>	8.5
<b>J1</b>	M12
<b>K (mm)</b>	15.0
<b>L (mm)</b>	8.5
<b>L1 (mm)</b>	31.5
<b>M (mm)</b>	13.5
<b>M1 (mm)</b>	9.0
<b>N (mm)</b>	58.5
<b>N1 (mm)</b>	-
<b>Ø O (mm)</b>	50
<b>P</b>	M8
<b>Q</b>	G1/4

<b>R (mm)</b>	60.0
<b>R1 (mm)</b>	62.00
<b>R2 (mm)</b>	61
<b>SW (mm)</b>	17
<b>T (mm)</b>	4.0
<b>U (mm)</b>	-
<b>V (mm)</b>	48.00
<b>AA (mm)</b>	12
<b>BB (mm)</b>	8.5
<b>Ø CC (mm)</b>	14.0
<b>Ø DD (mm)</b>	9.0
<b>EE (mm)</b>	15.0
<b>FF</b>	M6
<b>LL (mm)</b>	62.0
<b>MM (mm)</b>	80.0
<b>NN (mm)</b>	80
<b>RR (mm)</b>	62.0
<b>VV (mm)</b>	-
<b>Z (mm)</b>	8.5