

## Short stroke magnetic cylinders - Series QP-QPR

Product code: QP3A080A035

Datasheet creation date: 10/03/2025 00:09

Check the most updated document online [click here](#)



### TECHNICAL DATA

<b>Series</b>	QP = standard
<b>Diameter (mm)</b>	80
<b>Operation</b>	3=double-acting through rod
<b>Materials</b>	A = rolled stainless steel
<b>Construction</b>	A = standard
<b>Stroke type</b>	N = standard
<b>Stroke (mm)</b>	35
<b>Atex</b>	No Atex
<b>Rod lenght (mm)</b>	0

## Short stroke magnetic cylinders - Series QP-QPR

Product code: QP3A080A035

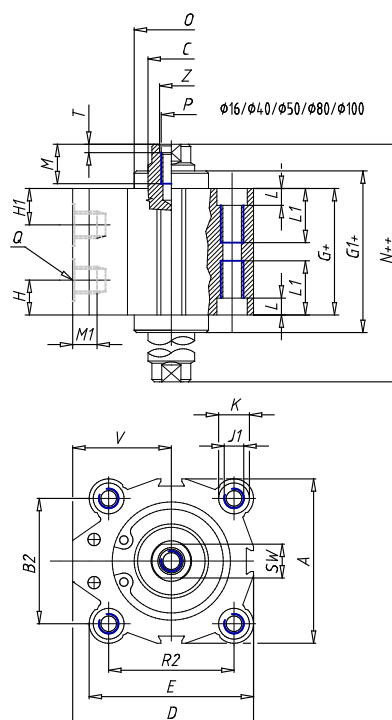

### DIMENSIONS

A (mm)	98.0
B (mm)	-
B1 (mm)	-
B2 (mm)	77
Ø C (mm)	25
D (mm)	104.00
E (mm)	98.00
G (mm)	57.5
G1 (mm)	0
H1 (mm)	16.2
H (mm)	16.2
J (mm)	10.5
J1	M12
K (mm)	17.0
L (mm)	10.5
L1 (mm)	31.5
M (mm)	15.0
M1 (mm)	10.5
N (mm)	69.5
N1 (mm)	-
Ø O (mm)	62
P	M16
Q	G3/8

R (mm)	-
R1 (mm)	-
R2 (mm)	77
SW (mm)	22
T (mm)	4.0
U (mm)	-
V (mm)	55.00
AA (mm)	15
BB (mm)	10.0
Ø CC (mm)	16.5
Ø DD (mm)	11.0
EE (mm)	17.0
FF	M8
LL (mm)	77.0
MM (mm)	100.0
NN (mm)	100
RR (mm)	77.0
VV (mm)	-
Z (mm)	16.5