

## Short stroke magnetic cylinders - Series QP-QPR

Product code: QPR2A020A070

Datasheet creation date: 09/03/2025 23:31

Check the most updated document online [click here](#)



### TECHNICAL DATA

<b>Series</b>	QPR = anti-rotation
<b>Diameter (mm)</b>	20
<b>Operation</b>	2=double-acting
<b>Materials</b>	A = rolled stainless steel
<b>Construction</b>	A = standard
<b>Stroke type</b>	= variable
<b>Stroke (mm)</b>	70
<b>Atex</b>	No Atex
<b>Rod lenght (mm)</b>	0

## Short stroke magnetic cylinders - Series QP-QPR

Product code: QPR2A020A070

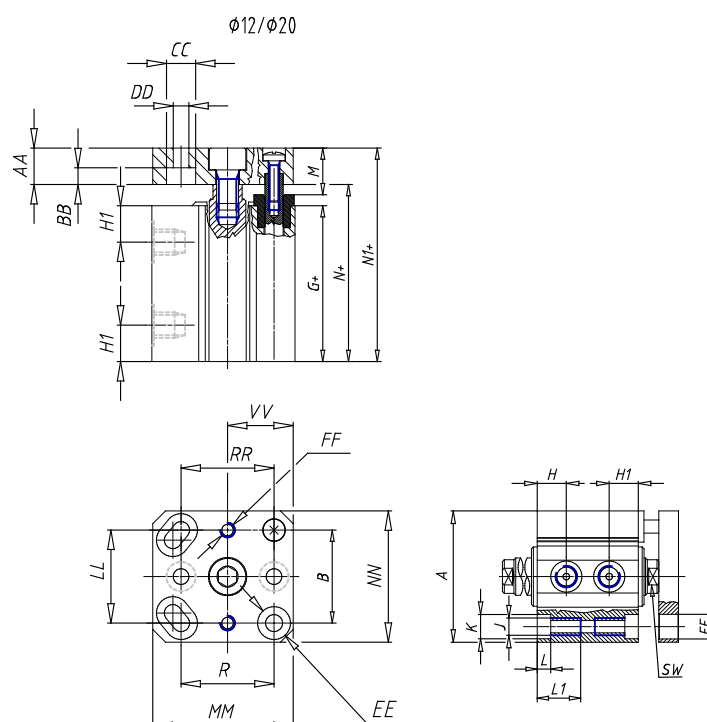

### DIMENSIONS

A (mm)	37.0
B (mm)	25.5
B1 (mm)	20
B2 (mm)	-
Ø C (mm)	10
D (mm)	39.25
E (mm)	39.25
G (mm)	31.2
G1 (mm)	-
H1 (mm)	9.8
H (mm)	9.8
J (mm)	5.5
J1	-
K (mm)	9.0
L (mm)	6.0
L1 (mm)	-
M (mm)	11.0
M1 (mm)	4.5
N (mm)	36.0
N1 (mm)	46
Ø O (mm)	19.5
P	M6
Q	M5

R (mm)	25.5
R1 (mm)	27.75
R2 (mm)	-
SW (mm)	8
T (mm)	-
U (mm)	15
V (mm)	20.75
AA (mm)	10
BB (mm)	4.6
Ø CC (mm)	8.0
Ø DD (mm)	4.2
EE (mm)	9.0
FF	M4
LL (mm)	25.5
MM (mm)	38.5
NN (mm)	36
RR (mm)	25.5
VV (mm)	18
Z (mm)	-