

## Bidirectional flow controller - Series RFO

Product code: RFO 383-1/8

Datasheet creation date: 10/03/2025 12:14

Check the most updated document online [click here](#)



### TECHNICAL DATA

Mod.	RFO 383-1/8
------	-------------

## Bidirectional flow controller - Series RFO

Product code: RFO 383-1/8

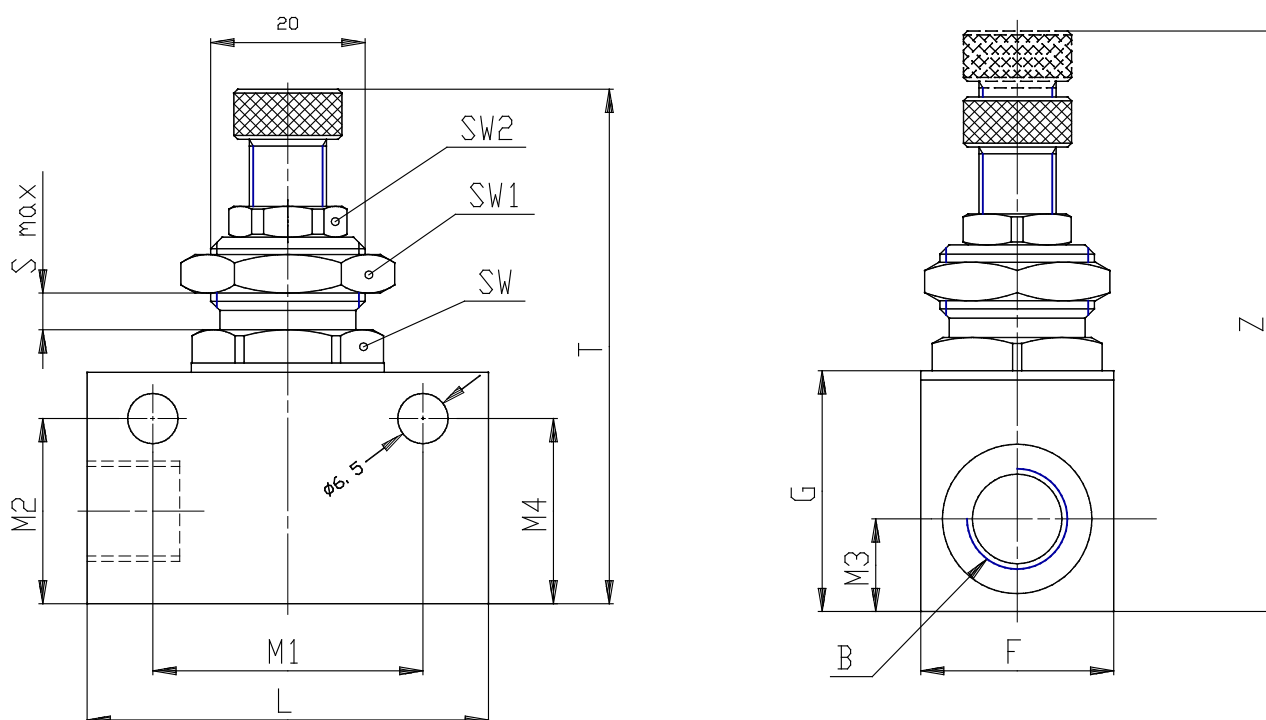

### DIMENSIONS

Ø N (mm)	3.0
A	M 12x1
B	G1/8
D (mm)	4.5
F (mm)	16
G (mm)	21
L (mm)	34
M1 (mm)	24.5
M2 (mm)	16.5
M3 (mm)	8
M4 (mm)	16.5
T (mm)	46
Z (mm)	51.0
S MAX (mm)	4
SW (mm)	14
SW1 (mm)	17
SW2 (mm)	9