

Unidirectional flow controller - Series RFU

Product code: RFU 483-02

Datasheet creation date: 10/03/2025 12:14

Check the most updated document online [click here](#)



TECHNICAL DATA

Mod.	RFU 483-02
------	------------

Unidirectional flow controller - Series RFU

Product code: RFU 483-02

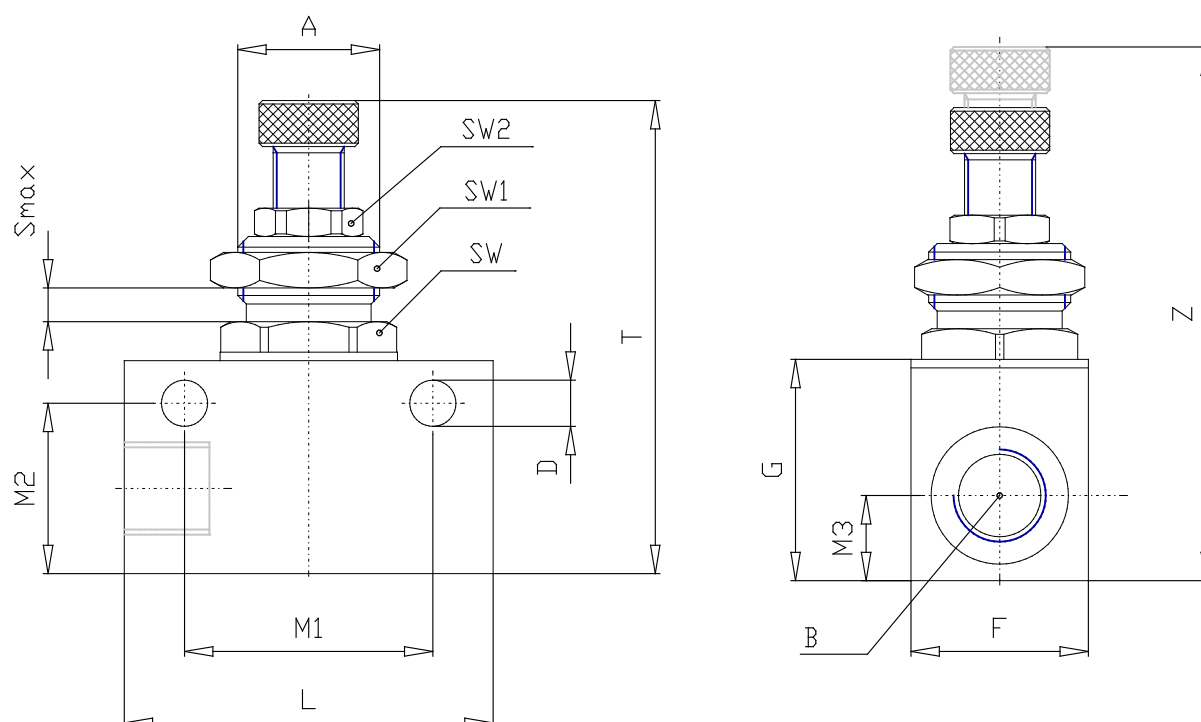

DIMENSIONS

A (mm)	M 12x1
B (UNF NPTF)	1/8
H (INCH)	0.354
D (INCH)	0.177
F (INCH)	0.630
G (INCH)	0.827
L (INCH)	1.339
M1 (INCH)	0.965
M2 (INCH)	0.650
M3 (INCH)	0.315
T (INCH)	1.811
Z (INCH)	2.008
SMAX (INCH)	0.157
SW (INCH)	0.551
SW1 (INCH)	0.669
SW2 (INCH)	0.354