

Unidirectional flow controller - Series RFU

Product code: RFU 483-1/8

Datasheet creation date: 10/03/2025 12:14

Check the most updated document online [click here](#)



TECHNICAL DATA

MOD (Mod.)	RFU 483-1/8
------------	-------------

Unidirectional flow controller - Series RFU

Product code: RFU 483-1/8

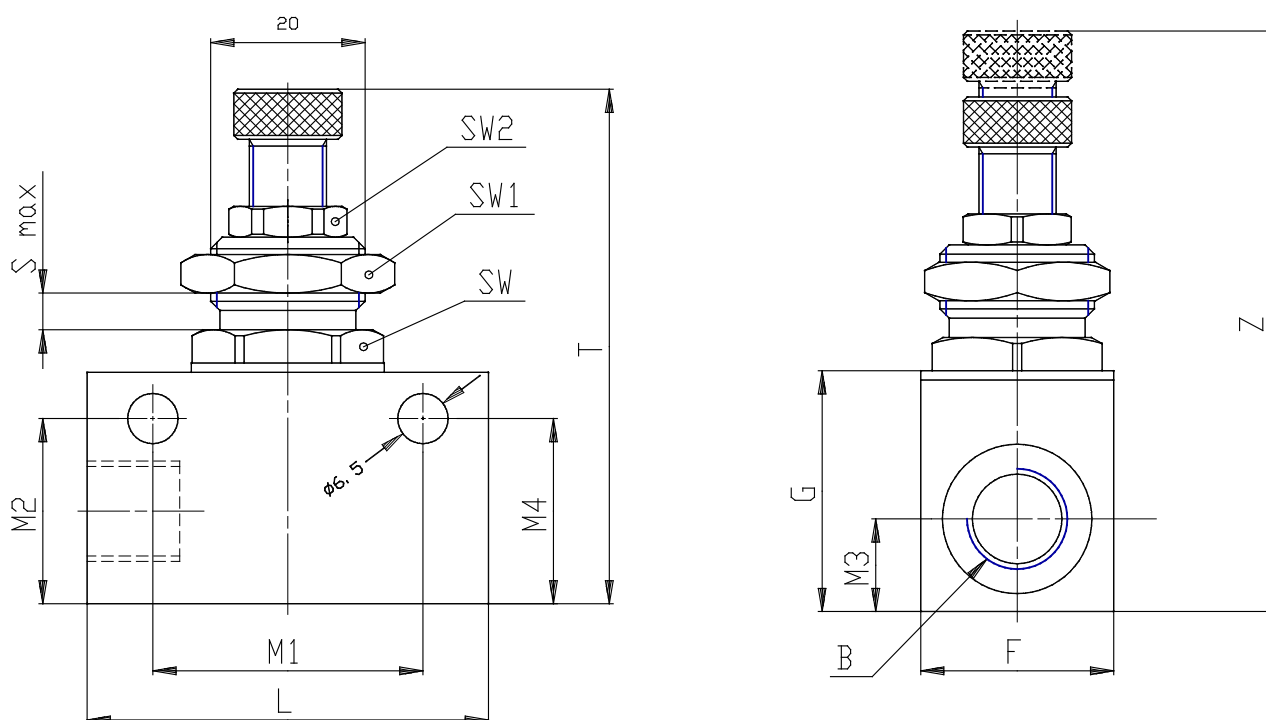

DIMENSIONS

PHYN (Ø / mm)	3.0
A (A)	M 12x1
B (B)	G1/8
D (D / mm)	4.5
F (F / mm)	16
G (G / mm)	21
L (L / mm)	34
M1 (M1 / mm)	24.5
M2 (M2 / mm)	16.5
M3 (M3 / mm)	8
M4 (M4 / mm)	16.5
T (T / mm)	46
Z (Z / mm)	51.0
S MAX (S MAX / mm)	4
SW (SW / mm)	14
SW1 (SW1 / mm)	17
SW2 (SW2 / mm)	9