

Rod Lock - Series RL

Product code: RLC-41-100

Datasheet creation date: 07/03/2025 16:05

Check the most updated document online [click here](#)



TECHNICAL DATA

Mod.	RLC-41-100
Series	RCL= standard, complete with cartridge and housing
Cylinder Series	41
Diameter (mm)	100

Rod Lock - Series RL

Product code: RLC-41-100

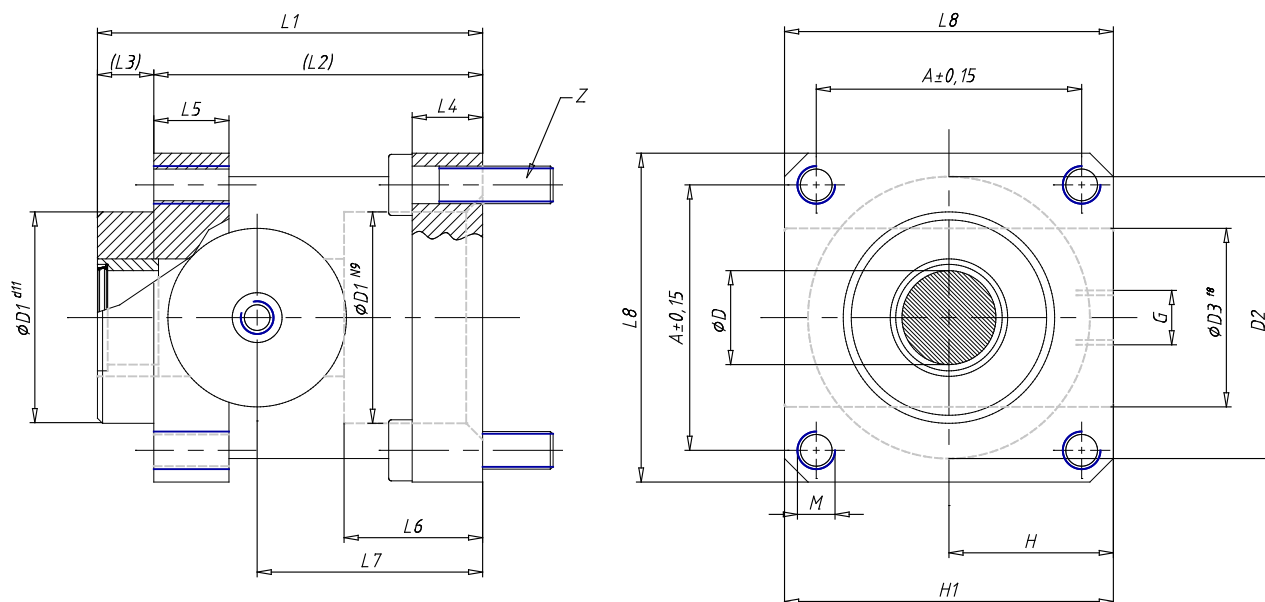

DIMENSIONS

D (mm)	25
A (mm)	89.0
D1 (mm)	55.0
D2 (mm)	100
D3 (mm)	58
G	G1/8
H (mm)	58.0
L (mm)	0
L1 (mm)	115
L2 (mm)	100
L3 (mm)	15
L4 (mm)	18
L5 (mm)	20
L6 (mm)	39.0
L7 (mm)	69.0
L8 (mm)	105
M	M10
H1 (mm)	110.5
Z	M10x35