

Rod Lock - Series RL

Product code: RLC-41-32

Datasheet creation date: 07/03/2025 16:05

Check the most updated document online [click here](#)



TECHNICAL DATA

Mod.	RLC-41-32
Series	RCL= standard, complete with cartridge and housing
Cylinder Series	41
Diameter (mm)	32

Rod Lock - Series RL

Product code: RLC-41-32

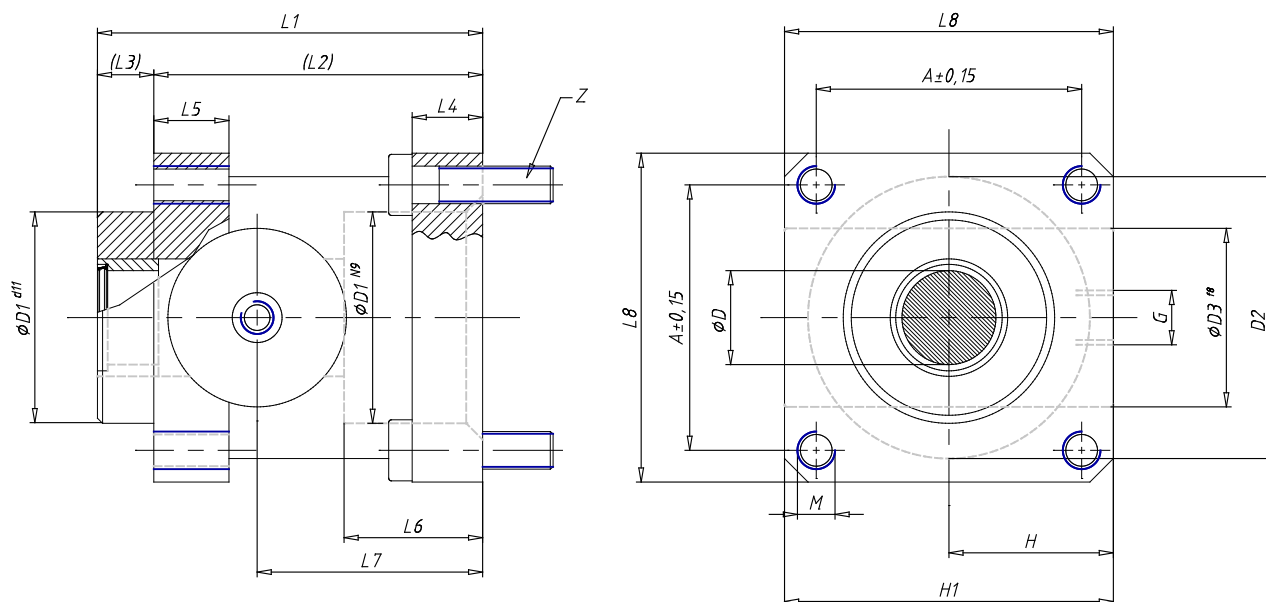

DIMENSIONS

D (mm)	12
A (mm)	32.5
D1 (mm)	30.5
D2 (mm)	35
D3 (mm)	25
G	G1/8
H (mm)	25.5
L (mm)	0
L1 (mm)	58
L2 (mm)	48
L3 (mm)	10
L4 (mm)	8
L5 (mm)	13
L6 (mm)	20.5
L7 (mm)	34.0
L8 (mm)	45
M	M6
H1 (mm)	46.5
Z	M6x20