

Rod Lock - Series RL

Product code: RLC-41-40

Datasheet creation date: 07/03/2025 16:05

Check the most updated document online [click here](#)



TECHNICAL DATA

Mod.	RLC-41-40
Series	RCL= standard, complete with cartridge and housing
Cylinder Series	41
Diameter (mm)	40

Rod Lock - Series RL

Product code: RLC-41-40

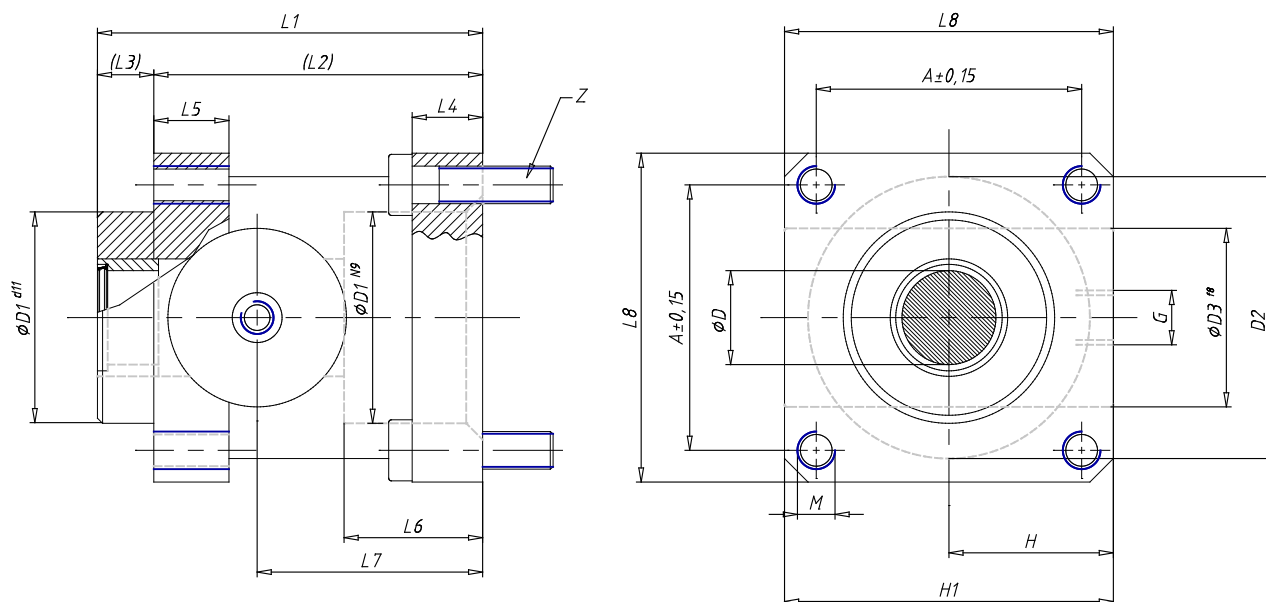

DIMENSIONS

D (mm)	16
A (mm)	38.0
D1 (mm)	35.0
D2 (mm)	40
D3 (mm)	28
G	G1/8
H (mm)	30.0
L (mm)	0
L1 (mm)	65
L2 (mm)	55
L3 (mm)	10
L4 (mm)	8
L5 (mm)	13
L6 (mm)	22.5
L7 (mm)	38.0
L8 (mm)	50
M	M6
H1 (mm)	53.0
Z	M6x20