

Rod Lock - Series RL

Product code: RLC-41-63

Datasheet creation date: 07/03/2025 16:06

Check the most updated document online [click here](#)



TECHNICAL DATA

Mod.	RLC-41-63
Series	RCL= standard, complete with cartridge and housing
Cylinder Series	41
Diameter (mm)	63

Rod Lock - Series RL

Product code: RLC-41-63

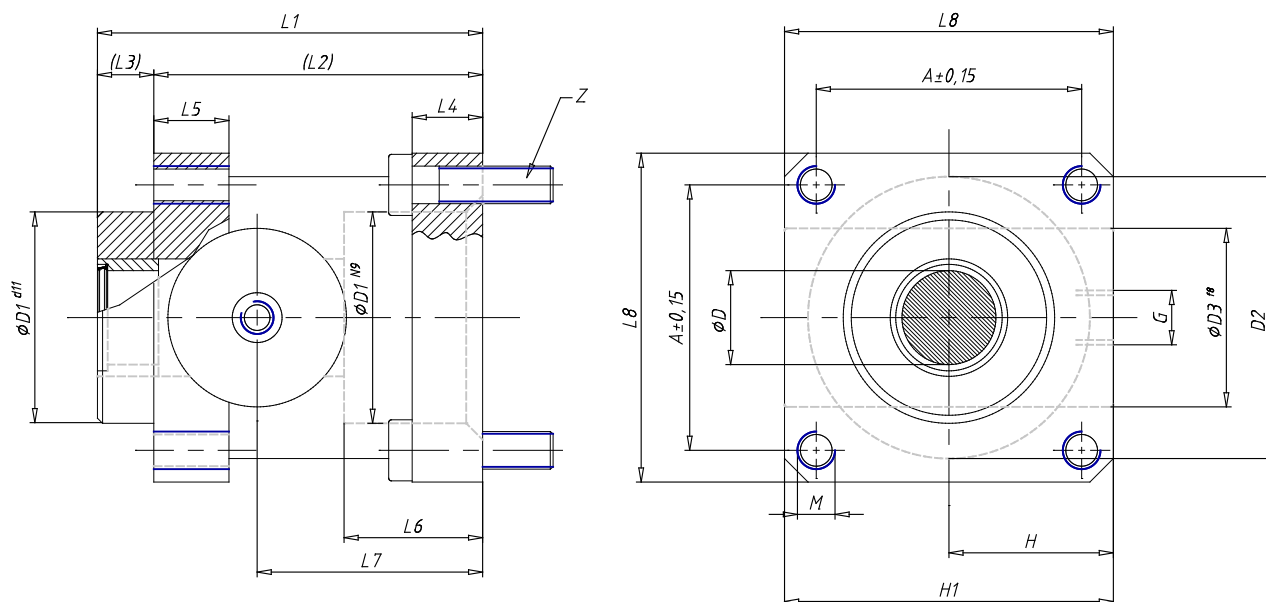

DIMENSIONS

D (mm)	20
A (mm)	56.5
D1 (mm)	45.0
D2 (mm)	60
D3 (mm)	38
G	G1/8
H (mm)	40.0
L (mm)	0
L1 (mm)	82
L2 (mm)	70
L3 (mm)	12
L4 (mm)	15
L5 (mm)	16
L6 (mm)	29.5
L7 (mm)	49.5
L8 (mm)	70
M	M8
H1 (mm)	75.0
Z	M8x30