

Short stroke antirotation cylinders - Series RPA

Product code: RPA20R010A14

Datasheet creation date: 10/03/2025 00:15

Check the most updated document online [click here](#)



TECHNICAL DATA

Series	RPA
Diameter (mm)	20
Version	R = Anti-rotation
Stroke (mm)	10
Construction	A = Standard
Stud (mm)	14 = 14mm

Short stroke antirotation cylinders - Series RPA

Product code: RPA20R010A14

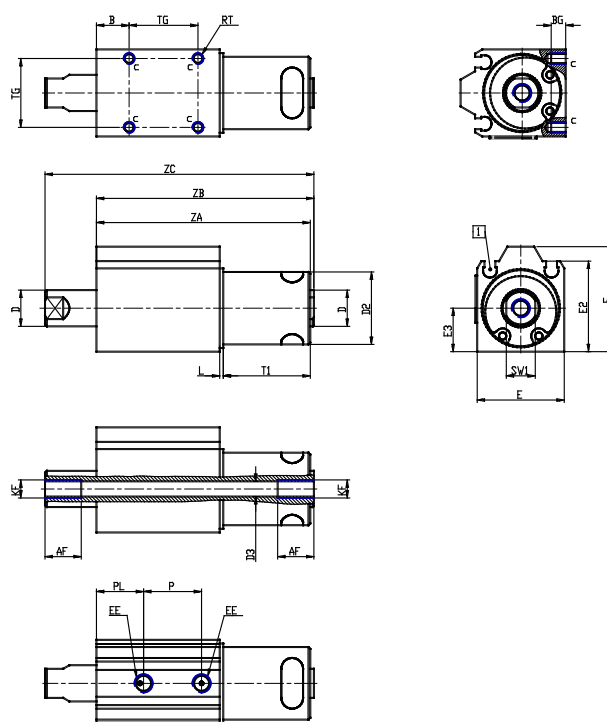

DIMENSIONS

AF (mm)	10
B (mm)	9
BG (mm)	4
D (mm)	10
D2 (mm)	14
D3 (mm)	4.2
E (mm)	24
E2 (mm)	25
E3 (mm)	12
F (mm)	29
KF (mm)	5.000
L (mm)	1
P (mm)	16.0
PL (mm)	13.0
R (mm)	8
RT (mm)	3
SW1 (mm)	8
T1 (mm)	24
TG (mm)	19
ZA (mm)	59
ZB (mm)	60
ZC (mm)	74.2