

## Short stroke antirotation cylinders - Series RPA

Product code: RPA20R025A14

Datasheet creation date: 10/03/2025 00:15

Check the most updated document online [click here](#)



### TECHNICAL DATA

<b>Series</b>	RPA
<b>Diameter (mm)</b>	20
<b>Version</b>	R = Anti-rotation
<b>Stroke (mm)</b>	25
<b>Construction</b>	A = Standard
<b>Stud (mm)</b>	14 = 14mm

## Short stroke antirotation cylinders - Series RPA

Product code: RPA20R025A14

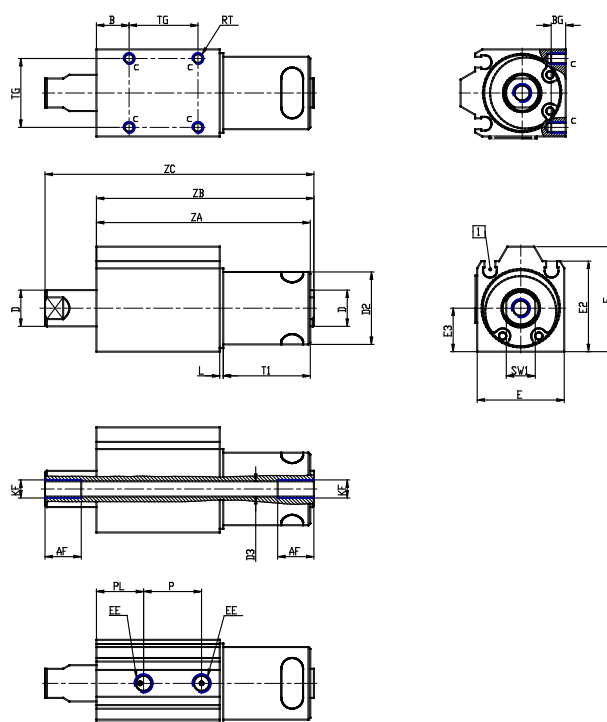

### DIMENSIONS

AF (mm)	10
B (mm)	24
BG (mm)	4
D (mm)	10
D2 (mm)	14
D3 (mm)	4.2
E (mm)	24
E2 (mm)	25
E3 (mm)	12
F (mm)	29
KF (mm)	5.000
L (mm)	1
P (mm)	31.0
PL (mm)	13.0
R (mm)	8
RT (mm)	3
SW1 (mm)	8
T1 (mm)	39
TG (mm)	19
ZA (mm)	89
ZB (mm)	90
ZC (mm)	119.2