

Robot tool changer - Series RTC

Product code: RTC-90-R

Datasheet creation date: 10/03/2025 02:39

Check the most updated document online [click here](#)



■ TECHNICAL DATA

Series	RTC
Sizes	90
Version	R = Robot

Robot tool changer - Series RTC

Product code: RTC-90-R

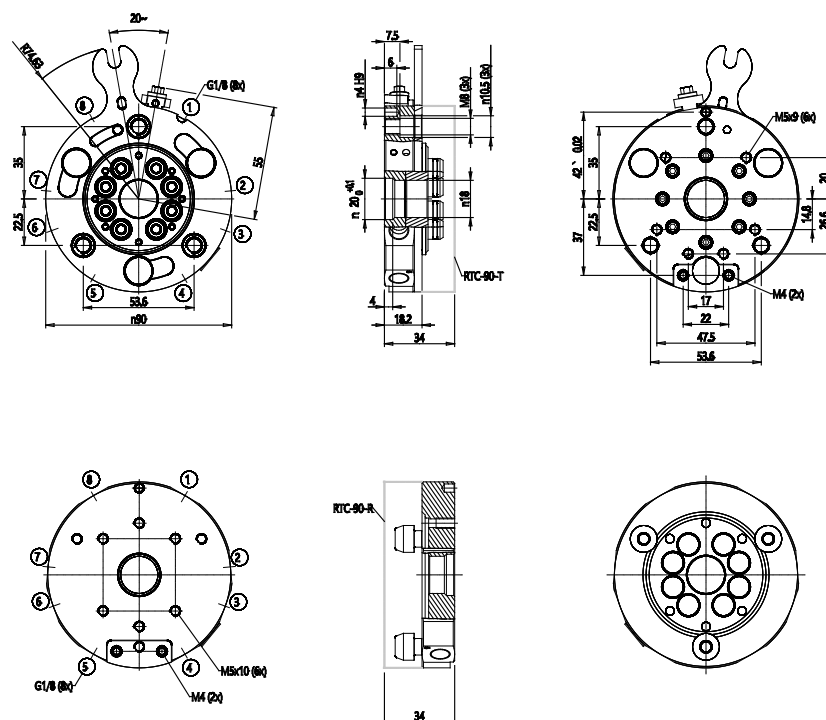

DIMENSIONS

Series	RTC
Sizes	90
Version	R = Robot