

Mounting bands for sensors CST - CSH - Mod. S-CST

Product code: S-CST-10

Datasheet creation date: 07/03/2025 14:30

Check the most updated document online [click here](#)



TECHNICAL DATA

Mod.	S-CST-10
Description	for cylinders Ø80 Series 90

Mounting bands for sensors CST - CSH - Mod. S-CST

Product code: S-CST-10

S-CST-05...12

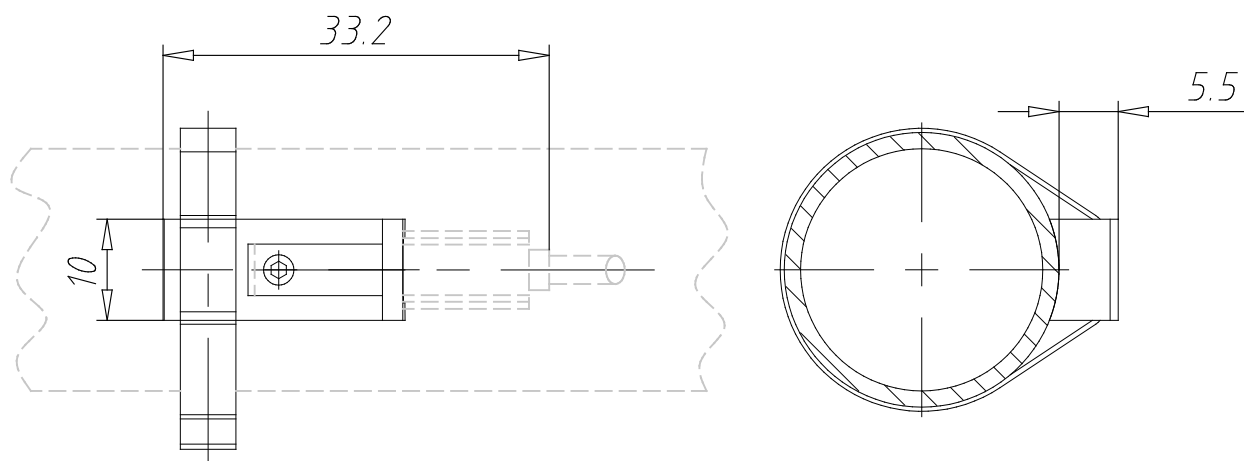

DIMENSIONS

Mod.	S-CST-10
Description	for cylinders Ø80 Series 90