

Mounting bands for sensors CST - CSH - Mod. S-CST

Product code: S-CST-45N1

Datasheet creation date: 07/03/2025 14:31

Check the most updated document online [click here](#)



TECHNICAL DATA

Mod.	S-CST-45N1
Description	for cylinders Series 60 Ø32-63 with guides Series 45

Mounting bands for sensors CST - CSH - Mod. S-CST

Product code: S-CST-45N1

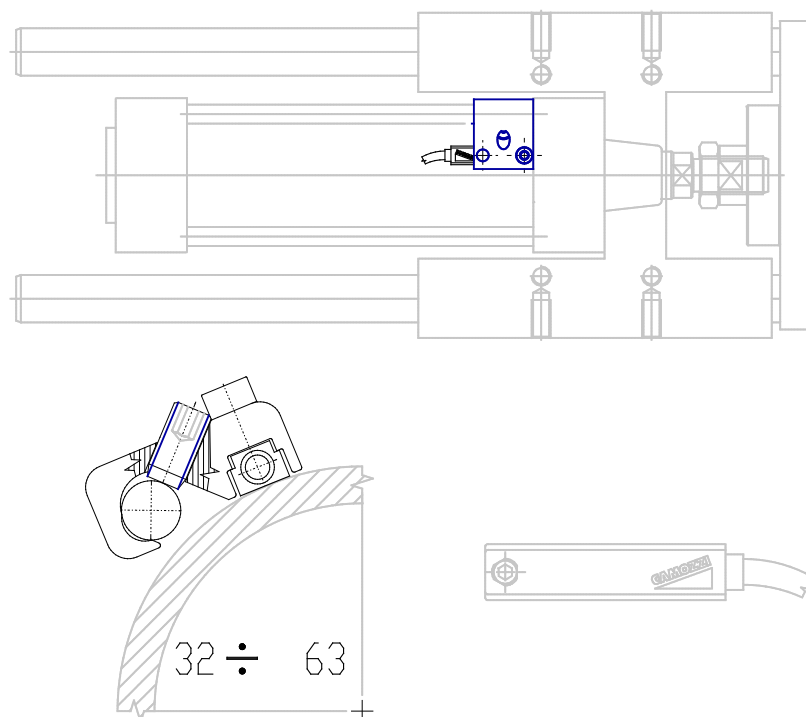

DIMENSIONS

Mod.	S-CST-45N1
Description	for cylinders Series 60 Ø32-63 with guides Series 45