

Mod. S2510 - Sprint fittings Serie S2000

Product code: S2510 1/8-1/4

Datasheet creation date: 10/03/2025 02:59

Check the most updated document online [click here](#)



TECHNICAL DATA

Mod.	S2510 1/8-1/4
------	---------------

Mod. S2510 - Sprint fittings Serie S2000

Product code: S2510 1/8-1/4

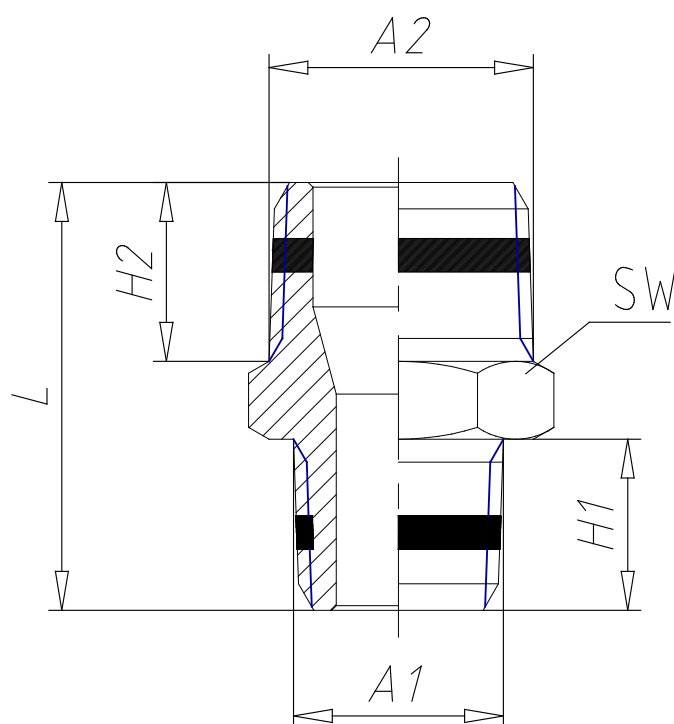

DIMENSIONS

A1	R1/8
A2	R1/4
H1 (mm)	7.5
H2 (mm)	11.0
L (mm)	23.5
SW (mm)	14