

Mod. S2510 - Sprint fittings Serie S2000

Product code: S2510 3/8-1/2

Datasheet creation date: 10/03/2025 02:59

Check the most updated document online [click here](#)



TECHNICAL DATA

Mod.	S2510 3/8-1/2
------	---------------

Mod. S2510 - Sprint fittings Serie S2000

Product code: S2510 3/8-1/2

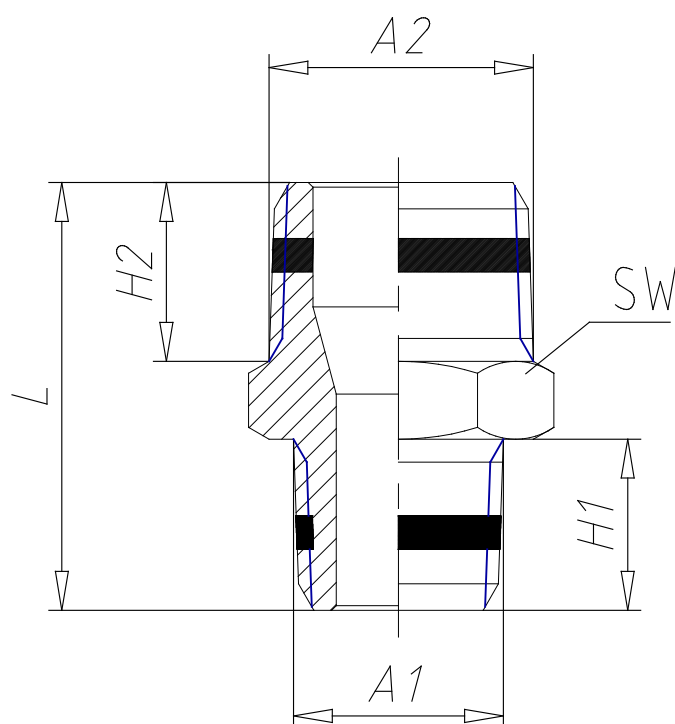

DIMENSIONS

A1	R3/8
A2	R1/2
H1 (mm)	11.5
H2 (mm)	14.0
L (mm)	31.0
SW (mm)	22