

Mod. S2530 - Sprint fittings Serie S2000

Product code: S2530 1/2-1/8

Datasheet creation date: 10/03/2025 02:59

Check the most updated document online [click here](#)



TECHNICAL DATA

Mod.	S2530 1/2-1/8
------	---------------

Mod. S2530 - Sprint fittings Serie S2000

Product code: S2530 1/2-1/8

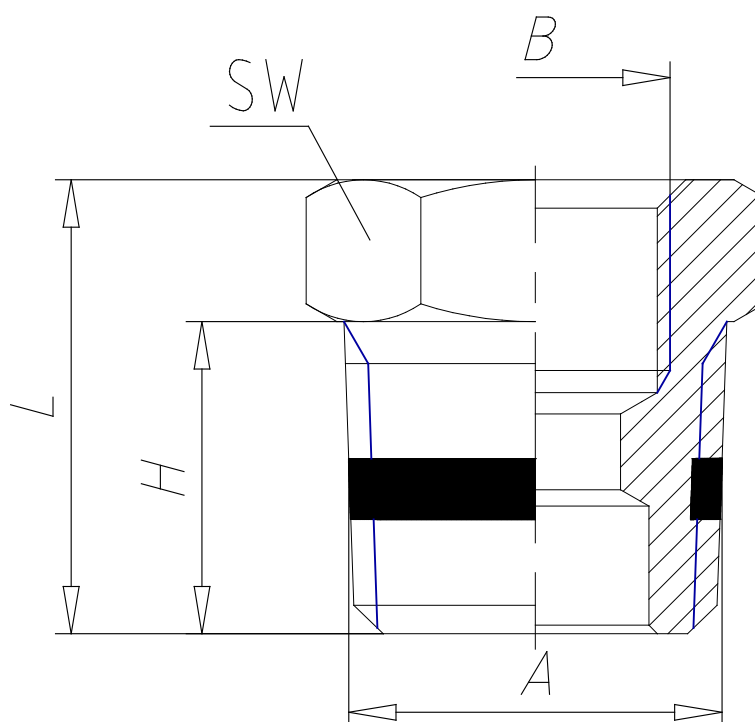

DIMENSIONS

A	R1/2
B	G1/8
H (mm)	14.0
L (mm)	19.5
SW (mm)	22