

Bracket with threaded pins - Mod. T

Product code: T-27-50

Datasheet creation date: 07/03/2025 15:56

Check the most updated document online [click here](#)



TECHNICAL DATA

Mod.	T-27-50
------	---------

Bracket with threaded pins - Mod. T

Product code: T-27-50

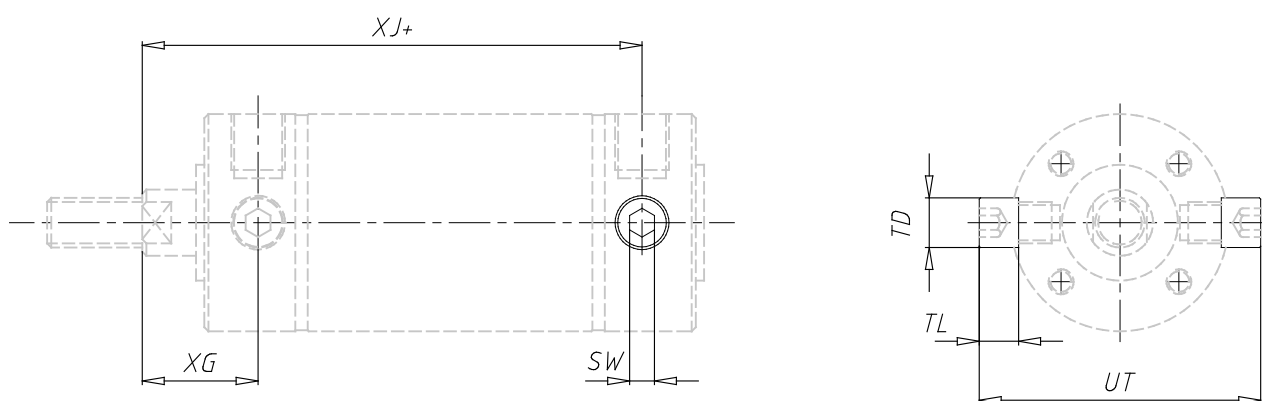

DIMENSIONS

SW (mm)	6
Ø TD h9 (mm)	12
TL (mm)	9.5
UT (mm)	68
XG (mm)	26
XJ (mm)	84